

Trapper Education

Student Manual



Trapper Education Student Manual



Layout, design and text by:

Bob Bluett/ Safety Education Section/ OLE
Illinois Department of Natural
Resources
One Natural Resources Way
Springfield, Illinois 62702

Graphic artwork by Joe Goodman (J.G.) is protected by copyright laws

ACKNOWLEDGMENTS

Financial support for printing and graphic artwork was provided by the Illinois State Furbearer Fund through a project application submitted by the Illinois Trappers Association. We thank hunters and trappers who contributed to the Illinois State Furbearer Fund by purchasing Habitat Stamps.

We thank the following organizations for permission to reproduce graphic artwork:

Illinois Trappers Association
Minnesota Trappers Association
Missouri Department of Conservation
National Trappers Association
North American Fur Association
New York State Department of Environmental Conservation
Pennsylvania Game Commission

We thank the following experts for reviewing a draft of this manual: Bob Aaron, George Hubert, Jr.,
David Stain, John C. Wilson, Dan Woolard, Neal Graves

PREFACE

Illinois' first Trapper Education courses were held in 1981. In 1985, the Trapper Education course was mandated for all first-time trappers under the age of eighteen to be issued a trapping license. The Department of Conservation, in partnership with the Illinois Trapper Association (ITA), began a statewide program of volunteer trapper safety education instructors.

This manual will provide you with an introduction to trapping and is intended to provide the information needed to trap furbearers responsibly and ethically. Individuals considering trapping must be willing to accept the responsibilities that come with it.

This manual is a partnered effort of the ITA and the Illinois Department of Natural Resources (IDNR). Over the years, volunteers and employees have dedicated many hours towards this program. The result of their knowledge and experiences, plus information from past manuals, have been combined to provide this updated version.

Funding for the trapping program comes through a reimbursable grant called the Federal Aid in Wildlife Restoration Act, popularly known as the Pittman-Robertson Act. The Act was approved by Congress in 1937.

Any reference to specific products or manufacturers does not imply endorsement by the associations or agencies involved in the production of this publication.

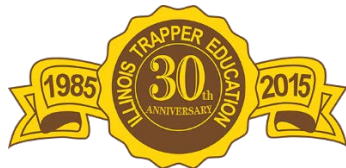

For further information on trapping or safety education programs, contact the IDNR.

If you lose the card that certifies your successful completion of a Trapper Education course, you may obtain a replacement by going to our website:

www.dnr.illinois.gov
Safety Education Section

Equal opportunity to participate in programs of the Illinois Department of Natural Resources (IDNR) and those funded by the U.S. Fish and Wildlife Service and other agencies is available to all individuals regardless of race, color, religion, sex, national origin, ancestry, age, order of protection status, marital status, physical or mental disability, military status, sexual orientation, pregnancy, or unfavorable discharge from military.

If you believe you have been discriminated against, contact the funding sources civil rights office and/or the Equal Employment Opportunity Officer, IDNR, One Natural Resources Way, Springfield, IL 62702-1271; 217/785-0067; TTY 217/782-9175.

Illinois Trapper Education Manual

Table of Contents

Code of Ethics	1	Fur grading terms	61
Trapping laws	6	Use & Disposal of carcasses	63
Types of traps	12	Home tanning	65
Trap maintenance	17	Wildlife management	66
Trap modification	19	Best management practices	67
Basic equipment	21	Brief history of trapping	68
Baits, lures and scents	27	Being an advocate	69
Before the season	28	North American Model of Wildlife Conservation	70
Water sets	29	IDNR policy on trapping	72
Land sets	35	Being an advocate	66
Checking traps	40	IDNR policy on trapping	67
Killing trapped animals	41	Species profiles	74
Fur handling	42	Body-gripping removal	87
Marketing your fur	59	Trap size guide for Illinois	90
		Selected references	91

CODE OF ETHICS

Regulated trapping provides many benefits to society. For example, it helps to keep wildlife populations at acceptable levels, reduces property damage, supports broader conservation programs and obtains many products for human use.

While all of these are good reasons for people to support regulated trapping, its future also depends on their perceptions of you and your actions on the trapline. You can do your part to insure the future of regulated trapping in Illinois by:

- Knowing and obeying trapping laws.
- Assisting in enforcement of trapping laws by reporting violations.
- Respecting landowners' property and obtaining permission as required by law.
- Considering animal welfare in your choice of capture, release and killing methods.
- Avoiding waste by caring for fur properly and marketing other useful products.
- Checking traps daily as required by law, preferably early in the morning.
- Disposing of carcasses properly.
- Supporting national, state and local trapping organizations.
- Assisting Illinois' Trapper Education program by becoming a certified instructor
- Promoting trapping by communicating its benefits, especially among non-trappers.
- Avoiding non-target catches.
- Helping landowners to reduce property damage caused by furbearers.
- Reporting the presence of diseased animals and endangered or threatened species to the proper authorities.
- Respecting others who participate in outdoor activities.
- Keeping up-to-date on improvements in trapping equipment and methods.

Your success as a trapper is not measured by numbers alone.

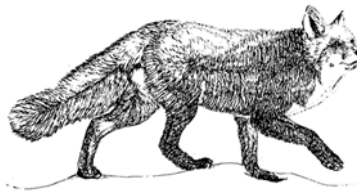

“You are your brother’s keeper. Your actions reflect either credit or discredit on the thousands of others who run traplines in Illinois and across the nation”

ETHICS AND RESPONSIBILITY

“Key ingredients for trappers who care about their sport”

Many people view trapping and use of fur as controversial issues. Much of this controversy stems from misinformation and misunderstanding on both sides. As trappers, we know that our sport is a legitimate use of a natural renewable resource; but we often have trouble putting this in terms that non-trappers can understand or appreciate.

Few of us are accomplished public speakers or trained in public relations. Nevertheless, we communicate a message about our sport and about ourselves every time we mention that we are trappers.

Demonstrating ethics and responsibility while trapping sends many positive messages that non-trappers understand and appreciate more than any explanation. These values are understood universally and do not require extra time or special training. Yet, they tell people that we are proud to be trappers; we care about our sport and we care about the resource were using.

Maintain Good Landowner Relations

Obtaining permission to trap is more than the law. It is an opportunity to earn respect by respecting landowners and their property. Be polite and presentable while asking for permission. If it is granted, take time to make sure you know where the property lines are so that neighbor’s rights are upheld as well.

Ask the landowner or tenant if they have noticed damage or other problems caused by furbearers. Chances are that if you are taking time to ask permission from a landowner, the property has good habitat and high furbearer populations. Asking about damage will help to reinforce the point that trapping provides a service by reducing furbearer populations and the problems they can cause. By the same token, do not promise more than you can deliver.

As always, practice common sense and courtesy by leaving gates the way you found them, walking or using a four-wheeler when fields and field roads are too wet to drive, and avoiding sets that might result in non-target catches.

Many trappers send a short thank-you note to landowners and tenants. A holiday greeting card can mean a lot as well. Offering to help with a chore or dropping off a pheasant or some venison will do more than words can express.

Respect Other Outdoor Enthusiasts

Autumn and winter are a popular time for many outdoor activities like hunting, hiking, bird watching, and cross-country skiing. Taking the time to find out which activities are likely to take place on an area you are trapping is the first step in avoiding any misunderstandings between you, the landowner, and others sharing his property.

Most activities are compatible with trapping and do not require further thought. If an area receives a lot of hunting pressure, you can time your use of a property to avoid peak times that hunters tend to choose like opening weekends and holidays. If this is not practical, use the most selective traps and trapping techniques to reduce the chances of a non-target catch. Doing so will improve your skills, image, and satisfaction.

Keep Familiar with Improvements in Trapping Equipment and Techniques

Nearly all trappers have looked for better ways to do the same job. While this usually involves years of refinement and a realization that simple methods often work best, new developments in equipment and methods often have a place in specific applications or even broader use.

Body-gripping traps, like Conibears, are a good example. Many trappers considered them “gadgets” when they were first made available. Today, they form the backbone of the muskrat and beaver trapping industry.

Improving efficiency, selectivity, and humaneness is not a new idea for the trapping industry. Many time-honored techniques addressed these concerns about trapping. However, research and development are occurring at a faster pace today and require more effort to keep abreast of state-of-the-art developments in equipment and methods.

Keeping up-to-date with new developments is easier today than it was in the past. Some sources are: trapper magazines and newsletters, online sites, presentations at trapping conventions, instructional books and videos, and contact with other trappers at fur sales and conventions.

Membership in state and national trapping organizations will help you become a more successful and responsible trapper.

Trapping technology and techniques continue to improve and be become more efficient. Check online sites to keep current with new techniques.

Some Methods for Improving Efficiency, Selectivity and Humaneness

Use pan tension devices to avoid non-target catches.

Use extra swivels and center-mounted chains to hold animals and reduce the chance of injuries.

Use modern positioning techniques at dirt hole sets to increase selectivity.

Use short trap chains for most land sets, especially those targeted for fox and coyote.

Use guarded or “stop-loss” traps for muskrats in shallow water or dry land sets.

Use dispatching methods that are quick and humane.

Use trap sizes that are appropriate for the target species. Pad catches are desirable for fox, coyote, raccoon, bobcat, and others because they cause fewer injuries.

Use baits and lures that attract target species but not, other animals.

Use cage, box, or species-specific traps near barns, outbuildings, and other locations where domestic animals may be present.

Use common sense in choosing set locations that maximize opportunities to catch target species and minimize opportunities to catch other animals.

Use secure methods of attaching traps. Tailor methods to hold the largest species you may catch.

Use traps with padded or laminated jaws where the risk of non-target catches is high.

Use discretion when setting body-gripping traps.

Use time to your advantage. Do not set more traps than you can handle.

Use early morning trap checks. This will reduce the time an animal is held, reducing its chances of escape, and avoid theft of traps and animals.

Trappers have an obligation to show respectful behavior toward all wildlife. Even in the act of killing an animal, you must show it respect when it is alive and after you have dispatched it.

Appreciate Perceptions of Non-trappers

Trappers who act responsibly and ethically do not have anything to hide. However, they need to appreciate the fact that most people know little or nothing about trapping.

Differences in backgrounds, culture, and experiences can cause misinterpretations of your words, deeds, and actions. Keep this in mind when communicating with non-trappers. Put yourself in their place if you want an honest evaluation of how you are portraying your sport. Make an effort to communicate on their level. Above all, remember that high standards of ethics and responsibility form a message that cannot be mistaken.

Respect the Resource

Ethical trappers respect the resource they use. Part of this involves making the most of your catch. Follow proper pelt handling procedures and take pride in your work at all times. Look for secondary markets for carcasses, castoreum, and other by-products. Utilize by-products for baits and lures when possible. If not, dispose of them properly.

Wildlife laws are designed to conserve our fur resources while allowing for responsible use. Become familiar with and obey all regulations. Report violations to the Conservation Police. Violators are stealing from trappers and non-trappers alike, as well as giving the sport a bad name.

Conclusion

You may be the only trapper that many people will ever know. Leave them with a good impression by upholding high standards of ethics and responsibility in your words, deeds, and actions. Be proud to be a trapper and a good representative for others who enjoy the sport.

“Trapping’s rewards are great, not only in the harvest of fur, but in the very special satisfactions gained from time spent afield. Accept your share with gratitude and don’t waste a precious gift.”

“Always play the game fairly. Your sense of accomplishment and pride in your success will be all the greater”

Maintain Good Landowner Relations

Respect Other Outdoor Enthusiasts

Keep Familiar With Improvements in Trapping Equipment and Techniques

Appreciate Perceptions of Non-trappers

Respect the Resource

**Trapping:
Privilege vs. Right**

In most states, trapping is a privilege available to all citizens who choose to follow regulations and behave responsibly. In Illinois, regulated trapping is a privilege, trappers who violate laws can lose their privilege to trap. If trappers as an overall group do not behave responsibly, citizens could decide to take away this privilege and stop all trapping.

Illegal or unethical behavior is not acceptable. Show respect for wildlife, people, and property.

TRAPPING LAWS

Trapping is highly regulated. Laws are enforced by specially trained Conservation Police Officers. Laws that pertain to trapping help to:

- Protect species from becoming endangered.
- Improve animal welfare.
- Prevent non-target catches.
- Limit trapping to times of the year when furs are marketable and young animals are no longer dependent on their mothers.
- Monitor harvest levels via mandatory reports.
- Support habitat conservation and wildlife studies through license sales and other fees.
- Protect landowners' rights and interests by acquiring permission before setting traps.

The IDNR monitors wildlife populations and adjusts season dates and bag limits accordingly. Some of the more permanent trapping regulations are presented in the manual, but they are subject to change. For a copy of the most recent Digest of Hunting and Trapping Regulations go to:

<https://www.dnr.illinois.gov/hunting/Pages/HuntingTrappingDigests.aspx>

LICENSE, STAMP, TRAPPER EDUCATION, AND OTHER REQUIREMENTS

Trapper Education Mandate

No trapping license shall be issued to any person born on or after January 1, 1998 unless he or she presents evidence that he/she held a trapping license issued by this state or another state in a prior year, or a certification card issued by the Department upon successful completion of a trapper education course.

Trapping License

Any person who traps furbearing mammals in Illinois must first procure a trapping license from the IDNR. The ONLY EXCEPTION to this rule is: an owner or bonafide tenant of farmland and his children actually living on the farmland where they trap.

If required to purchase a trapping license, you must carry it with you while trapping and present it immediately for inspection by any authorized law enforcement officer.

Trapping licenses expire annually on March 31 of each following year.

Non-resident trapping licenses are available. Contact the IDNR Office of Systems and Licensing (217/782-2965) for details.

Youth Trapping License

Resident youth age 18 and under may trap while supervised by a parent, grandparent, or guardian who is 21 or older. Completion of a trapper education course is waived for Resident Youth Licenses.

Habitat Stamp

Any person who traps fur-bearing mammals in Illinois must first secure a State Habitat Stamp from the IDNR. The ONLY EXCEPTIONS to this requirement are for disabled veterans and ex-POW's.

Landowners and bonafide tenants who are exempt from license requirements must still purchase a State Habitat Stamp.

If you purchased an Illinois habitat stamp for hunting, you do not need to buy a separate one for trapping. One stamp covers both activities, but you must carry it with you while engaged in either one. If carried separately, stamps must be affixed to a license or signed across the face.

Reporting Requirements

The IDNR relies on surveys of licensed trappers to estimate harvest levels and harvest effort for legal species. We also ask for your input on local furbearer populations, observations of uncommon species, and issues like season dates and trapping equipment.

We use a sample of licensed trappers (generally 10-20% of those who purchased licenses) to save on costs while obtaining reliable information. Anyone who receives a survey is required by law to complete and return it.

Green hides must be sold within 20 days after the season closes

It is unlawful for trappers to possess green hides before the season begins or more than 20 days after it closes. For example, if the trapping season for muskrat ends on January 5th, you must sell or otherwise dispose of all untanned muskrat pelts by January 25th.

GLOSSARY OF TERMS

Furbearing Mammal

Fourteen species are defined as furbearing mammals. They include the badger, beaver, bobcat, coyote, gray fox, mink, muskrat, opossum, raccoon, river otter, red fox, striped skink, long-tailed weasel, and least weasel.

Green Hide

A green hide is any hide which has not been tanned. NOTE: "Green hide" includes pelts which have been stretched and dried but not tanned.

Land Set

Any trap or similar device which is not placed or set in contact with flowing or impounded water.

Water Set

Any trap or similar device which is placed in contact with flowing or impounded water.



Traps must be tagged or inscribed with your name and address. Rolling a metal tag around a link of the trap chain will help to reduce accidental losses.

Blaze garment requirement

It is unlawful to trap during the firearm deer season unless you wear a legal blaze color cap and vest or outer garment with at least 400 square inches of solid legal blaze color material.

Trap tags required

While in the field, all traps must be inscribed or tagged with metal tags that bear the owner's NAME AND ADDRESS. Stamped copper or brass tags are recommended. They are available from many trapping supply dealers. Write-on metal tags are not recommended because they seldom last for more than one or two catches.

Trapping on public roads and other rights-of-way prohibited

It is unlawful to hunt or trap along, upon, across, or from any public right-of-way or highway in the State of Illinois. NOTE: You may trap under or near roads located entirely on private land (like access lanes for farm equipment) but not on roads open to the public. Boundaries for public rights-of-way are best determined by looking for fences or contrasts in land use such as a grass road ditch (public) vs. a crop field (private). If in doubt, ask the landowner or tenant when you get their permission to trap.

Damaging or destroying dens and feed beds prohibited

It is unlawful to molest, destroy, or attempt to destroy any feed bed, nest, den, house, or any other cavity of any mammal protected by the Illinois Wildlife Code. A feed bed is defined as a mound, pile, or mat of branches, cattails, or other vegetation gathered by muskrats or beavers.

GENERAL TRAPPING LAWS

IT IS UNLAWFUL:

- For any person at any time to take, possess, sell, or offer for sale any fur-bearing mammal or part thereof, including green hides, contrary to the provisions of the Illinois Wildlife Code

GENERAL TRAPPING LAWS

IT IS UNLAWFUL:

- To fail to visit and remove all animals from traps at least once each calendar day.
- To use a foothold trap **on land** that has a jaw spread larger than 6 ½ inches or a body-gripping trap that has a jaw spread larger than 7 inches on a side if square and 8 inches if round.
- To use a foothold trap **in water** that has a jaw spread larger than 7 ½ inches or a body-gripping trap that has a jaw spread larger than 10 inches on a side if square and 12 inches if round.
- To use any trap with saw-toothed, spiked, or toothed jaws.
- To destroy, disturb, or in any manner interfere with dams, lodges, burrows, or feed beds of beaver while trapping for beaver or to set a trap inside a muskrat house or beaver lodge.
- To set traps closer than 10 feet from any hole or den which may be occupied by a game mammal, except that this restriction does not apply to water sets (you may legally set a trap within 10 feet of any den in water, but not on land).
- To trap any furbearing mammal with any colony, cage, box, or stove pipe trap designed to catch more than one animal at a single setting (It is legal to use single catch cage or box traps but not repeating or colony traps.)
- For any person to set or place any trap during the closed season. (No traps may be placed in the field, set or unset, during the closed season. However, you may set out stakes or floats before the season opens if no traps are attached to them.)
- To place, set, or maintain any foothold trap within 30 feet of bait placed in such a manner or position that it is not completely covered and concealed from sight, except that this shall not apply to underwater sets. (Bait means any bait composed of mammal, bird or fish flesh, fur, hide, entrails, or feathers)

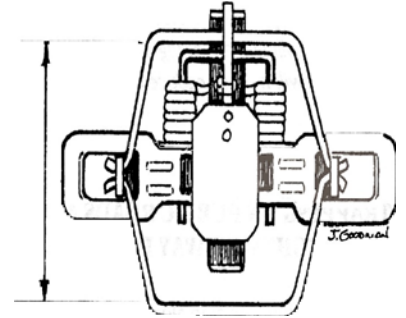

To determine the jaw spread of a trap, measure the distance from the inside edge of one jaw to the inside edge of the opposite jaw at the widest point. Foothold traps must have a jaw spread of 6 ½" or less if set on land and 7 ½" or less if the traps are touching water.



Using traps with toothed, spiked, or serrated jaws is prohibited in Illinois.



When making land sets, foothold traps must be located at least 30 feet away from exposed bait. This helps prevent the accidental capture of non-target animals like hawks and owls.

GENERAL TRAPPING LAWS

IT IS UNLAWFUL:

- To take beaver, mink, muskrat, or weasel except by trapping. However, beaver, river otter, weasel, mink, and muskrat can be shot with a firearm, pistol, or air-gun of a caliber not larger than a .22 long rifle to remove the animal from the trap.
- To use poisons, chemicals, or explosives to take any species protected by the Wildlife Code.
- To use deadfall, net, or pit trap to take any species protected by the Wildlife Code.
- To use spears, gigs, hooks, or any like device to take any species protected by the Wildlife Code.
- To place, set, use, or maintain a snare unless at least half of the loop is underwater at all times. When set, the snare loop must be 15" or less in diameter. Snares must be constructed of cable that is at least 5/64 inch but no more than 1/8" in diameter, and must be equipped with a mechanical lock, anchor swivel and stop device that prevents the snare loop from closing less than 2 1/2" in diameter. It is unlawful to use or possess cable or wire snares constructed of stainless steel metal (like piano wire).
- To trap beaver with: (1) a foothold trap or one of similar construction having a jaw spread of less than 5 1/2" or more than 7 1/2", or (2) a body gripping trap or one of similar construction having a jaw spread of less than 7" or more than 10" on a side if square and 12" if round. Except that these restrictions shall not apply during the open season for trapping muskrat. (You must use large traps to take beavers when the muskrat season is closed. For example, a 220 or 330 body-gripping trap or a #3 or #4 longspring.)

GENERAL TRAPPING LAWS

IT IS UNLAWFUL:

- For any person to trap or hunt upon the land of another or upon waters flowing over or standing on the land of another without first obtaining permission from the landowner or tenant.
- For any person to trap within 100 yards of an inhabited dwelling without first obtaining permission from the landowner or tenant.
- For any person to remove furbearing animals from, or to move or disturb in any manner, the traps owned by another person without written authorization from the owner to do so.
- To damage or destroy another person's property while trapping on their land.
- To fail to report any trapping accident involving serious personal injury (death, internal injury, broken bones, disfigurement, loss of an appendage, etc.) to the IDNR within five days. Accidents must be reported on forms obtained from the Safety Education Section at www.dnr.illinois.gov/safety

PENALTIES

Any person who violates any of these provisions may be fined up to \$500 and/or imprisoned for up to six months upon conviction.



You must obtain permission from the landowner or tenant of any property and from anyone who lives within 100 yards of where a trap is set.



**TO REPORT A VIOLATION, CALL
1-877-2DNRLAW
(236-7529)
OR
1-800-252-0163**

TYPES OF TRAPS

Traps come in many designs and sizes to catch different types of animals under different kinds of conditions. Traps can be divided into two main groups: live-restraining or kill-type traps.

LIVE-RESTRAINING TRAPS

Live-restraining traps are designed to capture an animal alive and unharmed. The most common types used in Illinois, are foot-hold traps and box or cage traps. These traps allow for the release of non-target animals.

KILL-TYPE TRAPS

Kill-type traps are designed to kill furbearers. The most common types are the body-gripping trap and cable snare. Illinois has strict regulations on the use of kill-type traps which includes size and location of sets. The use of these types of traps is highly regulated to avoid incidental catch of non-target animals.

Foothold traps

Foothold traps offer advantages like versatility, compact size, and the ability to release animals if desired. They are the only efficient way to catch species like coyote, red fox, and gray fox. Standard designs include coilspring, underspring, and longspring traps.

Foothold traps (i.e. dog proof) were invented specifically for capturing raccoons. These designs almost eliminate non-target catches because animals must reach through a small opening to access the trigger mechanism. Some designs also help to reduce injuries.

Longspring traps have been around for a long time because they're simple and effective. Single longspring traps are the best suited for small animals like mink and muskrat, especially when set near deep water where an animal will drown quickly. Double longspring traps are a better choice for drowning sets when targeting medium to large animals like raccoon and beaver.

Guarded or Stoploss™ traps are designed specifically for capturing muskrats in shallow water. The spring-loaded guard helps to restrict an animal's movement and ensure a quick death.

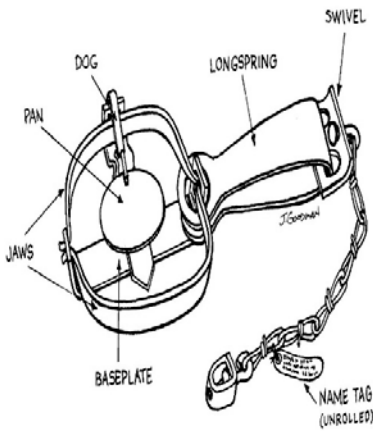

Single longspring trap

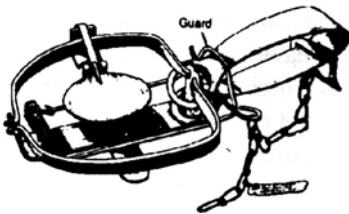

Guarded or Stoploss™ trap



Underspring trap

Underspring of “jump” traps are more compact than longsprings, making them easier to conceal. They are also lighter and stronger for a given size.

Coilspring traps are the fastest kind of foothold. They are generally preferred for capturing animals like coyote and fox because of their speed, strength, and compact size.

Padded traps offer all the advantages of other coilspring designs and reduce injuries to coyote and fox by about two-thirds. Newer models have stronger springs than the prototypes which allowed some animals to escape. Adding an extra set of coilsprings, called “four-coiling,” can add power without increasing injuries if a trap’s original springs are weak.

Enclosed Trigger traps, like an EGG or Duffer’s, require an animal to reach through a hole, grab the trigger, and pull up to fire. This makes them very selective for raccoon and opossum while eliminating nearly all non-target catches. A study in Illinois showed that EGG traps were as efficient for capturing raccoons as #11 longspring traps and caused only about a third as many injuries.

Set EGG or Duffer’s traps at home, they will not fire while you are carrying them on the trapline. Initial set construction is often faster and simpler with the EGG or Duffer’s traps than with standard models of foothold traps. However, an EGG or Duffer’s trap take longer to reset when you make a catch because it must be disassembled to remove the animal.

Size reference – Foothold traps

Model number	Jaw spread *
1 or 11	3 5/8 – 4 1/2”
1 1/2	4 3/4 - 5 1/8”
2	4 3/4 - 5 3/8”
3	5 1/2 - 6 1/2”
4	5 7/8 – 7 1/4”
5	7 1/2 “

* Actual dimensions for a given size vary among designs (e.g., coilspring vs. longspring) and manufacturers. Only traps with a jaw spread of 6 1/2” or less may be used on land; 7 1/2” is the maximum for water sets.

Choosing the right tool for the job will increase your catch while improving animal welfare.

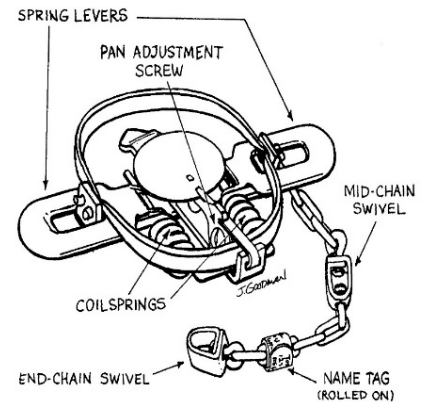

Coilspring trap

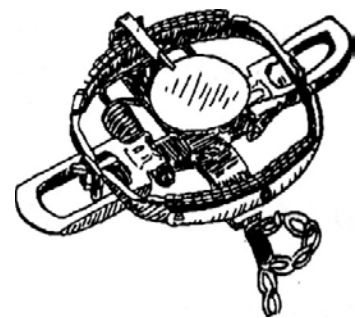

Padded or Softcatch trap

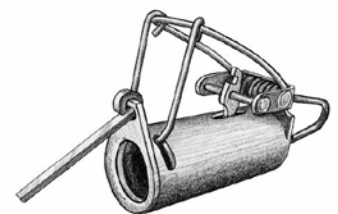

Dog proof trap or D.P.

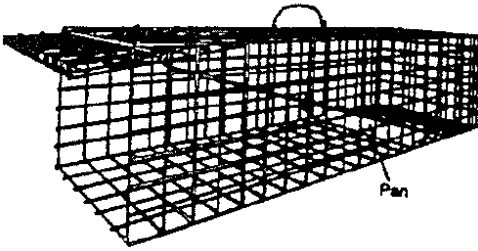

Cage trap

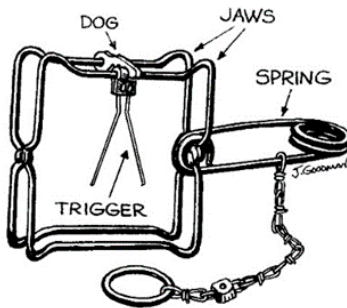

Body-gripping trap (set position)

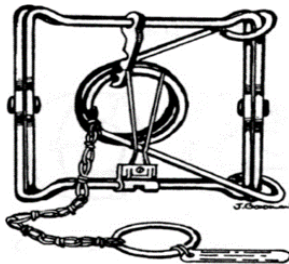

Body-gripping trap (sprung position)

Box or Cage traps

Box traps, also called cage traps, are an excellent choice for catching raccoons and opossums near homes or outbuildings. In these locations, using sweet baits like marshmallows or breakfast cereal, can help to avoid catching cats or other nontarget animals, thereby increasing your overall catch.

Box traps also have a place in more remote locations, especially when freezing weather makes it hard to keep foothold traps in operating order. Drawbacks include their cost and bulky size.

Body-gripping traps

Body-gripping traps, also called Conibear traps after the inventor, are designed to kill an animal quickly when two rotating jaws close on an animal's neck or chest. These traps are effective and popular for capturing semi-aquatic furbearers like muskrat, beaver, and mink. While medium-sized (up to a 7" jaw spread) body-gripping traps are allowed for land sets, they must be used with extreme caution because of the risk of capturing and killing non-target animals.

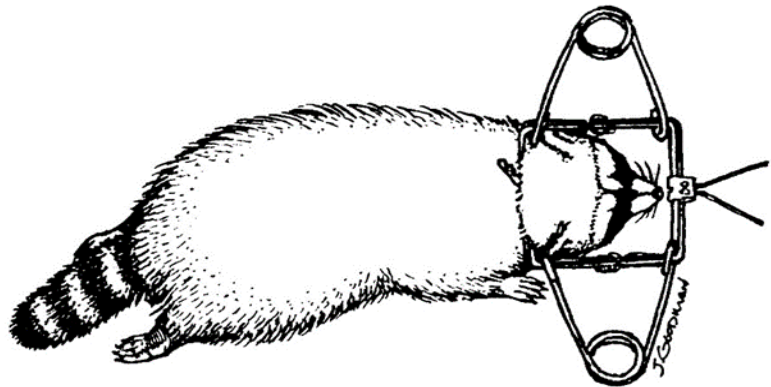

Proper strike location for a body-gripping trap. Animals die quickly and have little or no pelt damage.



Some manufacturers use a “Canadian bend” to increase killing power. Compared to standard models, the jaws close more tightly, and the springs exert more pressure when the trap is sprung. They are often called “magnum” models.

Size reference – Body-gripping traps

model number	jaw spread*
55	3 ½ x 4 ½”
110	4 ½ x 4 ½”
160	6 X 6”
220	7 x 7”
280	8 x 8”
330	10 x 10”

*Actual dimensions for a given size vary among manufacturers. Body-gripping traps that are set on land must have a jaw spread of 7” x 7” or less. Body-gripping traps that are set in water must have a jaw spread of 10” x 10” or less.

Use dog-proof sets and sweet baits or lures when making land sets with #220 body-gripping traps.

Snares

The use of snares is highly regulated in Illinois. For example, at least half of the loop must be submerged under water when the snare is set. Given this or other restrictions in Illinois, snares are best suited for capturing beavers in water sets. They are an excellent tool for taking beavers that are “trap-shy” because of past experiences with body-gripping traps.

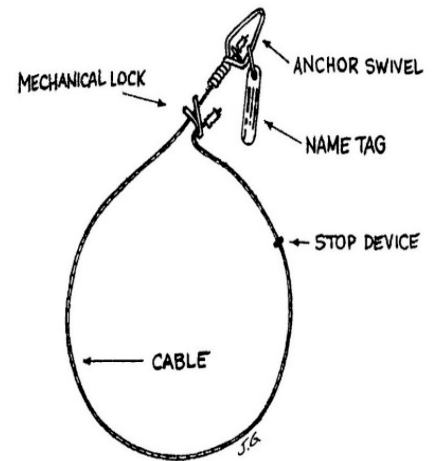

Snare or Cable restraint

You may not use or possess cable or wire snares constructed of stainless steel metal.

Recommended traps

<i>Muskrat</i>	#1 or #1 ½ longspring where water is deep enough to drown your catch quickly; #1 or #1 ½ guarded longspring for sets in shallow water; #110, #120 (double spring #110) or C120 Magnum™ body-gripping traps.
<i>Mink</i>	#1 ½ coilspring, #1 or #1 ½ longspring where water is deep enough to drown your catch quickly; #1 or #1 ½ guarded longspring for sets in shallow water; #60 (double spring #55), #110, #120, C120 Magnum™ or Bionic body-gripping traps.
<i>Raccoon & Opossum</i>	#1 ½ coilspring or #11 longspring (preferably with double jaws) where water is deep enough to drown your catch quickly; Dog proof traps for sets near shallow water; #160 or #220 body-gripping traps; cage traps (32" x 10" x 10").
<i>Red/gray fox</i>	#1 ½ or #1 ¾ coilspring (preferably with offset, laminated jaws and a short, center-mounted chain with a shock-absorbing spring); #1 ½ padded trap (larger traps may be necessary in areas where coyotes are common).
<i>Bobcat</i>	#1¾, #2, #3 coilspring (preferably with offset, laminated jaws and /or wide, short center-mounted chain, with 3 swivels and a shock absorbing spring); #1½ padded trap (larger traps may be necessary in areas where coyotes are common); #220 body-gripping traps; cage traps (42" x 15" x 20").
<i>Coyote & Badger</i>	#1 ¾, #2 or #3 coilspring (preferably with offset, laminated jaws and a short, center-mounted chain with a shock-absorbing spring); four-coiled #2 or #3 padded traps; #3 ½ EZ Grip.
<i>River otter</i>	#11, #1½, #1¾, #2, #3, #4, #5 foothold sizes or larger (preferably center mounted chain, with 3 swivels and a shock absorbing spring); #220, #280, #330 body-gripping traps.
<i>Beaver</i>	#4 or #5 longspring where water is deep enough to drown your catch quickly; #280 or #330 body-gripping traps (preferably magnum models); snares.

NOTE: Recommendations are subject to change as new technologies and research results become available.

TRAP MAINTENANCE

Traps are expensive. It makes sense to keep them in good working order. To do this:

- Inspect your traps and make any needed repairs before the season starts.
- Adjust triggers to increase efficiency and reduce non-target catches.
- Dye traps to increase their lifespan.
- Wax foothold traps used for land sets.

Inspect traps before the season starts

- Check trap chains for worn links.
- Check swivels for worn connectors.
- Compress trap springs to test their strength; replace weak springs.
- Set each trap to check the trigger adjustment.
- Make sure that every trap has a metal tag with your name and address (if you inscribed your name and address on the trap, make sure it is still legible).
- Look for burrs or nicks on the trap jaws; file them off.

Adjust trigger assemblies

The pan on a foothold trap should be level when set. Recent models of coil-spring traps have a pan adjustment screw. If you plan on using a trap for land sets, adjust the tension so that it triggers when you apply about three pounds of pressure to the pan. This will help to ensure a solid catch on a fox or coyote while allowing birds and small mammals to pass by. A can (cans from tennis balls work well) filled with enough sand to weigh three pounds can be used to test trigger tension.

Dye traps to prevent rust & corrosion

New traps are shipped with a light coating of grease on them. To remove it, put the traps in a large pot or wash tub and add dishwashing soap and warm water. Let the traps soak for a half hour. Remove the traps and hang them outside until a light coating of rust appears (about 1-2 weeks depending on weather conditions). This helps the dye to bond to the metal and will not hurt your traps.

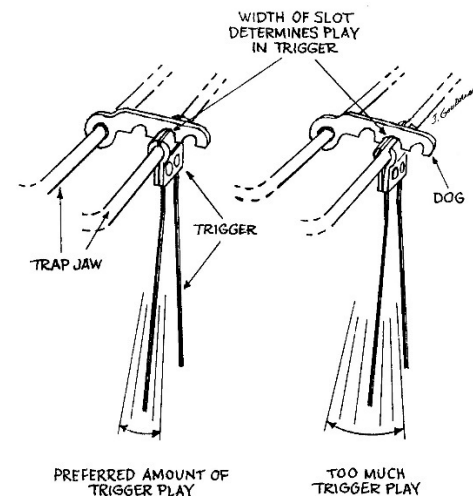
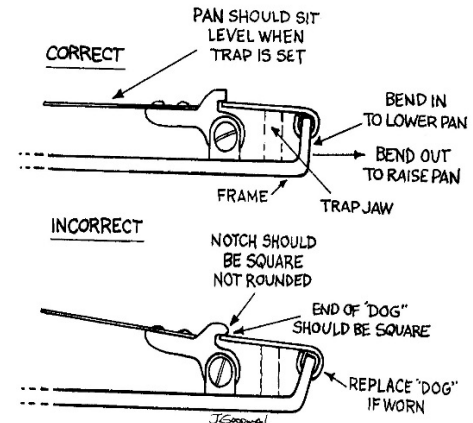

Too much “play” in the trigger can cause misfires and poor strike locations. Check the top of the trigger assembly for a gap. Use pliers or vise to crimp the trigger assembly until the ends are flush.

TIPS for dying traps:

- *When dying traps, place a nail between the jaws of each trap so that the wash solution and dye reaches the inside surface.*
- *You will get a harder and more even coating if you use petroleum-based dyes when temperatures are above 70 degrees.*
- *High temperatures can weaken trap springs; keep the solution at a low boil or simmer after the traps are added.*

TIPS for waxing traps:

- *Never wax body-gripping traps.*
- *If the wax coating appears thick and uneven, place the traps back in the water; and allow them to heat up a bit longer before removing them.*

Several kinds of dyes are available from trap supply dealers. Products like Speed Dip™ are popular because they are fast and simple. Add unleaded gasoline or white gas (the kind used for camp stoves) according to the manufacturer's directions, dip your pre-rested traps and hang them outside until dry.

Logwood powder or crystals are another popular way to dye traps. You will need a large pot or washtub and a fire (a propane cooker works well because you can adjust the heat). Measure clean water into the pot (see manufacturer's directions for amount) and bring it to a rolling boil. Add logwood ingredient. Reduce heat and let the traps soak in the solution. The longer the traps are in the solution, the darker they will get. A half hour to an hour is usually enough, but some people take the pot off the fire and let their traps soak for a couple of days if they are heavily rusted.

Walnut hulls and maple bark contain tannic acid, the same ingredient in logwood. You can collect these items and proceed as above, except boil the hulls or bark for an hour before adding your traps.

Wax foothold traps intended for land sets

Not all traps need to be waxed. In fact, you should **never wax body-gripping traps** because it makes them dangerously hard to set and causes misfires. A coat of dye is all that is needed to protect body-gripping traps.

Wax foothold traps, especially if you need intend to use them for land sets. Contact with wet soil and corrosive chemicals (salt is sometimes used to keep the soil from freezing) can be harsh.

To wax dyed traps, submerge them in clean, boiling water. Place trap wax (available from trapping supply dealers) in the water and allow it to melt. Pull traps through the layer of wax, then hang them up and allow them to cool.

Some trappers prefer to dip their traps in pure wax; no water. This method is unsafe for younger trappers because the wax must be kept at extremely high temperatures. **PARAFIN WAX IS FLAMMABLE** and can catch on fire or cause severe burns if splashed.

One way to avoid this problem is to use acrylic floor wax, which is applied at room temperature. It covers traps with a thin, even coat and tends to last longer than other waxes.

After the season

Take your traps to a car wash and clean them with a high-pressure sprayer. Inspect your traps and sort out any that need work. Store the rest in buckets with lids, milk crates, or plastic storage containers where they will stay dry. Traps used for land sets should be stored away from gas, oil, smoke, or chemicals that might leave an odor.

TRAP MODIFICATION

Most modifications serve one or more of the following purposes:

- Improving animal welfare.
- Reducing misses and escapes.
- Reducing pelt damage.
- Tailoring traps to methods you prefer, and conditions encountered most often on your trapline.

Books and videos have been dedicated to this subject. We encourage you to refer to them for a more complete overview. Our goal is to introduce a few modifications that you are likely to encounter – either as standard equipment in some manufacturers' products or as a topic magazine articles and trapping seminars.

Foothold traps

Swivels

Swivels help to reduce injuries by allowing a trap to move freely in the same direction as an animal's foot. They also make a handy way to attach traps to metal stakes or drowning wires.

Nearly all manufacturers use a swivel to connect the trap chain to the trap itself. This is usually adequate for trapping muskrats in drowning sets. We recommend two swivels for most other species and three for coyotes or traps equipped with long chains.

"Universal" or "four-way" swivels can be added to the middle of a trap chain to prevent it from binding. You can also attach them to the end of a chain for staking and drowning assemblies. "Box" swivels are usually rectangular. They can be added to the middle of a trap chain or used for drowning assemblies but are not as handy for staking.

Types of swivels:

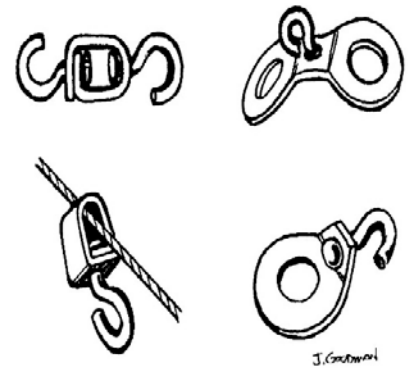

Clockwise from the upper left: "universal" or "four-way" swivel, cross-staking swivel, flat stake swivel, and the universal swivel used for a drowning assembly.

Some common staking assemblies for land sets:



Left to right: lap-link, stake swivel and universal swivel.

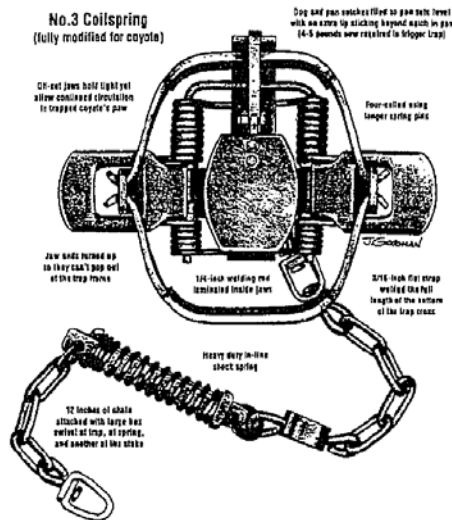

Trap modifications help to improve animal welfare while increasing your catch.

Stake swivels are designed for attaching traps to metal stakes. Some are designed for single staking systems. Others are designed for “cross-staking” or “double-staking.”

Cross-staking is recommended for coyotes, especially if soils in your area are light or sandy.

An S-hook tool comes in handy for closing rivets without damaging them. Consider welding the end of the rivet shut if you plan on trapping coyotes.

Lamination

Lamination refers to welding a piece of round or flat metal flush with the inside of the jaws of foothold traps. This increases the surface area of the jaws, helping to strengthen them and reduce injuries to trapped animals. Laminated jaws are popular modifications for traps used to catch coyote and fox.

“Four-coiling”

Some trappers add an extra set of springs to coilspring traps, especially if they plan on catching coyotes. “Four-coiling” helps the trap to close faster, especially in heavy soils or during periods of freezing and thawing temperatures.

The extra springs also help to keep a coyote’s foot from sliding back and forth between the trap jaws, thereby reducing injuries. Research on padded traps showed that “four-coiling” improves performance without increasing injuries to coyotes. Kits for “four-coiling” traps are available from trapping supply dealers.

Shock springs

Coyotes often lunge when trapped. Some trappers use a short (6-8”) trap chain to limit the distance a coyote can lunge, thereby reducing escapes and injuries. Other trappers prefer to use a longer trap chain and install a shock spring to absorb the impact.

Body-gripping traps

Swivels

Adding at least one swivel to the chains of #220 and #330 body-gripping traps can help to reduce pelt damage if an animal is not killed instantly.

It also keeps your wire from getting kinked or twisted, a problem that can cause it to break after a couple of catches.

Trigger configurations

Using the right trigger configurations can improve your percentage of quick kills. This is important not only for animal welfare, but for reducing pelt damage. Setting a trap “upside-down” (with the trigger at the bottom) is one way to avoid pelt damage because the jaw with the dog or trigger assembly closes on the animal’s throat instead of the back of its neck.

Proper trigger configurations help to increase your catch, improve animal welfare, and reduce pelt damage.

BASIC EQUIPMENT

You will have a hard time finding two trappers who agree about equipment. That is because there is no right, or wrong, only personal preference based on the type and number of sets you make.

Conditions on your trapline will also determine what you will need. For example, 18” or 24” metal stakes might be a good choice for anchoring raccoon traps in streams with hard clay bottoms. They would be worthless if you trapped streams with soft sandy bottoms, where wooden stakes 3-4” in length are needed to hold your catch.

This section introduces you to some general equipment needs. Your instructor can advise about what works best in your area.

Pan covers

Pan covers help to keep dirt from getting under the trap pan. They are necessary equipment for making land sets if you want your traps to fire consistently when an animal steps on the pan.

You can purchase pan covers or make your own from plastic bags, wax paper, fiberglass window screens, or landscaping fabric. They should be cut to fit the inside of the trap jaws when the trap is set. A slit or small cutout should be made where the pan cover lies over the dog. Some people cut soft foam to the shape of the trap pan and insert it under the pan before making a set.

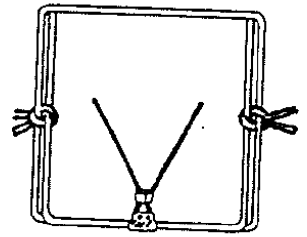

Suggested trigger configuration for raccoon. Also, the best configuration for beaver and river otter.

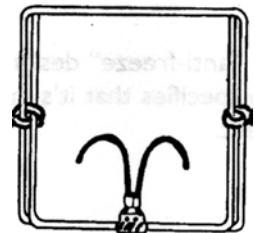

Suggested trigger configuration for mink.



Another modification for mink. Hammer the ends of the trigger wires until they're flat. Drill a 1/8” or 1/16” hole through each side. Tie a piece of 10-pound-test monofilament line between the holes.

Pan Cover

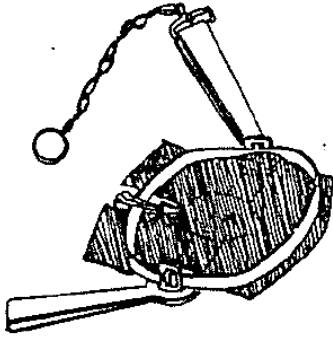

Dry, pre-sifted dirt

Many trappers carry dry, pre-sifted dirt when making land sets. This makes it easier to keep sets in good working order, especially when soil from the set location is wet or frozen.

Collect dirt during a summer dry spell. Sift it into clean storage containers, like 5-gallon pails with lids. Keep the containers in an area where they will not be exposed to odors from gas or chemicals.

Dirt sifter

Sifting removes dirt clods, pebbles, sticks, and other debris that might keep the trap jaws from closing quickly and completely. You can make your own sifter from galvanized hardware cloth with a 1/4" or 1/8" mesh.

A sifter comes in handy even if you carry pre-sifted dirt. Blend your set with its surroundings by sifting a fine layer of dirt, grass, or leaves from the set location as a finishing touch.

Anti-freeze

"Anti-freeze" is a convenient term for calcium chloride (used to melt ice from sidewalks) or other non-toxic chemicals available from trapping supply dealers. These products help to keep the soil from freezing over your traps. Even a thin layer of frozen dirt can keep traps from firing. Another option is to cover your traps with buckwheat hulls or "waxed dirt". These materials absorb very little moisture, so the particles tend to stay separated unless they get soaked with rain or a wet snow.

Note: Never use "anti-freeze" designed for cars unless the package specifies that it is safe for pets and the environment.

Catch pole

A catch pole is used to restrain non-target animals so that they can be released without injuries to them or yourself. You can purchase a catch pole or make your own. To make your own, use a 4-5' piece of conduit or other light pipe. Take a 10-12' length of aircraft cable (1/8" diameter), fold it in half and run the two loose ends through the conduit, leaving a loop on the other end. Attach a hardwood handle to the two loose ends.



Catchpole



Metal stakes

Use metal stakes for land sets. Most trapping supply dealers carry different styles and lengths. Stakes made from “rebar” with a washer welded on top are a common choice. Sharpening the points with a grinder makes the stakes easier to drive in the ground. It also allows dirt to pack tightly around the stake while it is pounded in, even in frozen ground.

A single 30” stake will hold coyotes in most areas. We recommend “cross-staking” with two 20-24” stakes if you trap in an area with light or sandy soils. Shorter stakes, 15-18” can be used for cross-staking in areas with clay or heavy soils.

Metal stakes are a common choice when targeting raccoon or beaver in areas where waterways have hard bottoms. Stakes 18-24” in length work well in clay soils; 24-30” is best for dark, heavy soils.

Stakes used for water sets often have a 4-5” piece of rebar welded to the top. Some trappers call them “T-bars” because of the shape. The top of the “T” makes a convenient handle for inserting and removing the stakes, especially when working underwater.

“Disposable” stakes

Some trappers use Super Stakes™ or disposable stakes. A special tool is used to drive the anchor into the ground. You set the anchor by pulling up on the attached cable. This causes the end of the anchor to shift off center, making it almost impossible to pull out if set properly.

One note of caution – disposable stakes can get caught up in farm equipment when left in crop fields. Be a responsible trapper and maintain good relations with landowners by using them only in untilled areas or removing them when you are finished.

Wooden stakes

Straight sections of hard maple, ash, hickory, oak, or osage orange (hedge) make good stakes. Softer woods can be used to anchor traps set for muskrat or mink. Cut stakes in late winter or early spring and allow them to “cure” over the summer. They will be lightweight and durable by trapping season.

Proper lengths are determined by soil conditions. Short stakes (2-3’ in length) are fine if waterways in your area have clay or hard mud bottoms. Use long stakes (3-5’ in length) in areas with sand or soft mud

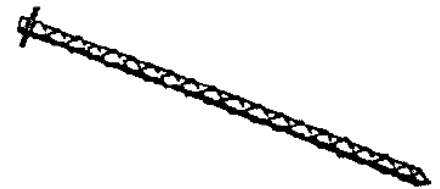

A rebar stake with a washer welded to the top.

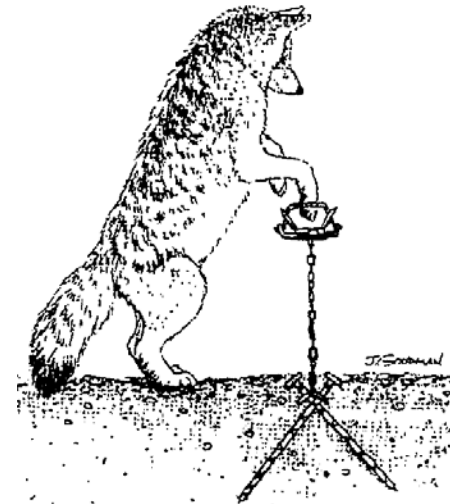

It is uncommon for a coyote to jump upward when held in a trap. Cross-staking works better than a single stake, especially in light soils. It also helps to prevent trap theft.

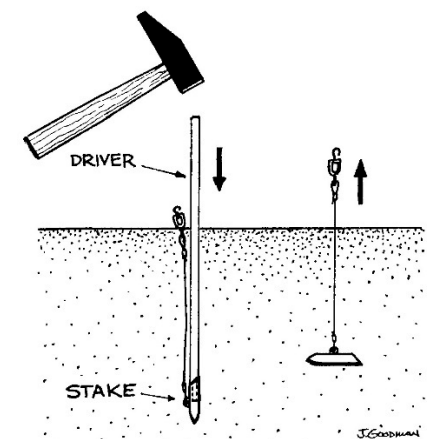

Super Stakes™ (also called disposable stakes)

Equipment checklist for land sets:

Long-handled trowel for digging trap beds and dirt holes

3-pound hammer for driving stakes and pounding trap beds

Pan covers or foam inserts

Dry, pre-sifted dirt

Dirt sifter

Anti-freeze (use only non-toxic products)

Catch pole

5-gallon bucket, gym bag, or trap basket for carrying equipment

Stakes or other anchoring systems

Lure and/or bait

Cotton or rubber gloves

Spare trap tags

.22 caliber gun for dispatching animals

Pliers for adjusting or repairing traps

Trap setters for body-gripping traps

Do not use fresh-cut stakes in areas with beavers – they might wind up as snacks.

Always anchor traps to hold the largest potential catch. Staking systems for coyotes should be used when targeting foxes.

Wire

Most trapping supply dealers sell three gauges of wire: 16, 14, and 11. The smaller the number, the larger the diameter and strength (# 11 gauge is the strongest).

Use only a good quality wire. “Baling wire” (the kind used to bundle hay bales) is too weak for attaching traps to anchoring systems, especially when targeting larger furbearers. Even the best wire develops weak spots if it gets rusted, kinked, or nicked. Avoid problems by replacing it.

Remember to always anchor traps to hold the largest potential catch. This includes sets for muskrat or mink that might catch a raccoon or beaver. When in doubt, use the largest gauge. If you do not have it with you, double a piece of smaller gauge wire, and twist it together along the entire length for maximum strength.

Common sizes and uses of wire

Gauge	Uses
16	Fastening bait to stakes, tree roots, etc.; attaching small (#110 or #120) body-gripping traps to anchoring systems.
14	Fastening baits; attaching large (#220 or #330) body-gripping traps to anchoring systems; attaching foothold traps to stakes when targeting muskrat or mink, especially in marshes and other locations where catching a raccoon is unlikely.
11	Attaching foothold traps to wooden stakes when targeting raccoons; attaching foothold traps to stakes when targeting muskrats in locations frequented by raccoons; assembling drowning slide-wires; positioning snares set for beavers.

Never use wire to attach traps to anchoring systems when targeting coyote or fox.

Plastic flagging

Remembering where you made a half-dozen sets is simple. Rely on your memory to locate 50 sets, and you will spend a lot of wasted time looking for them. Marking sets with colored, plastic flagging can help to avoid this problem. Dispose of the flagging properly when you remove your traps.

Setting tongs

Setting tongs are used to compress the springs on #220 and #330 body-gripping traps. The handles create enough leverage to do so easily; and once the springs are compressed, hook the safety catch with a free hand.

Safety catch for body-gripping traps

Catching your hand in a #330 body-gripping trap is more than embarrassing. It can be a real problem, especially if you are alone. To prevent this type of accident, set the trap and place a safety catch on the top two jaws. Position the trap. Remove the safety catch just before leaving the set.

Stabilizers for body-gripping traps

Several manufacturers make stands or mounts for positioning body-gripping traps. While not considered “essential” equipment, they can save a lot of time. Models that extend 2-3’ above the top of the trap allow you to place it safely in runways located in deep water. Possible drawbacks include the extra weight and bulk of manufactured stabilizers, especially if you need to carry them very far.

Slide-wire drowner

A slide-wire drowner consists of a length of aircraft cable (3/32”-1/8”) or strong wire with a one-way slide lock. Both ends of the cable are anchored – one on shore next to your set and the other in deep water where the animal drowns.

Slide-wire drowners are used mostly for capturing beaver or raccoon in foothold traps. They are effective only at set locations with deep water nearby. A minimum depth of 24” for raccoon and 42” for beaver.

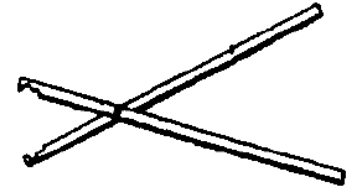

Setting tongs for body-gripping traps

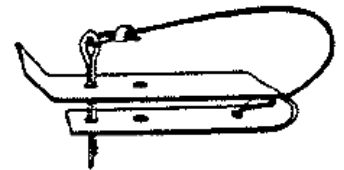

Safety catches for body-gripping traps

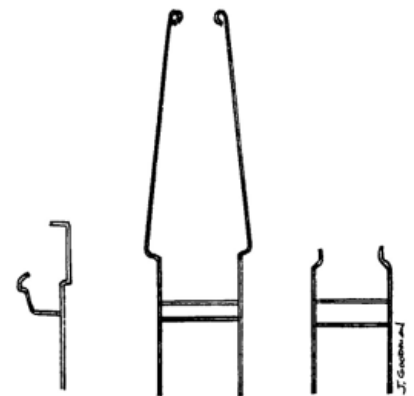

Body-gripping stabilizers



**Gauntlet
Gloves**

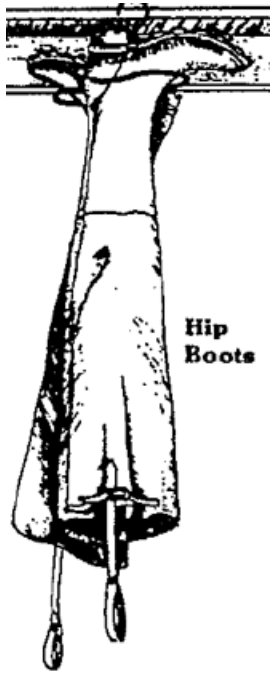

**Hip
Boots**



Pack Basket

Some advantages of slide-wire sets include:

- A quick dispatch of trapped animals.
- Fewer escapes, less pelt damage.
- Fewer problems with theft of your traps or fur.
- Less disturbance at set location, which allows you to re-make a set quickly.

Some disadvantages include the initial cost and time that it takes to make a set. These are usually offset by fewer escapes and less time needed to re-make a set after a catch.

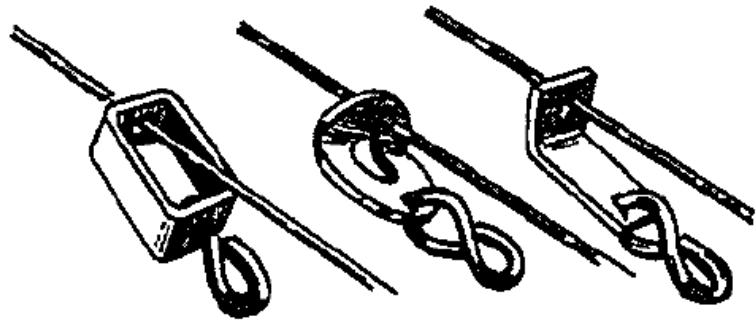

One-way slide-wire locks

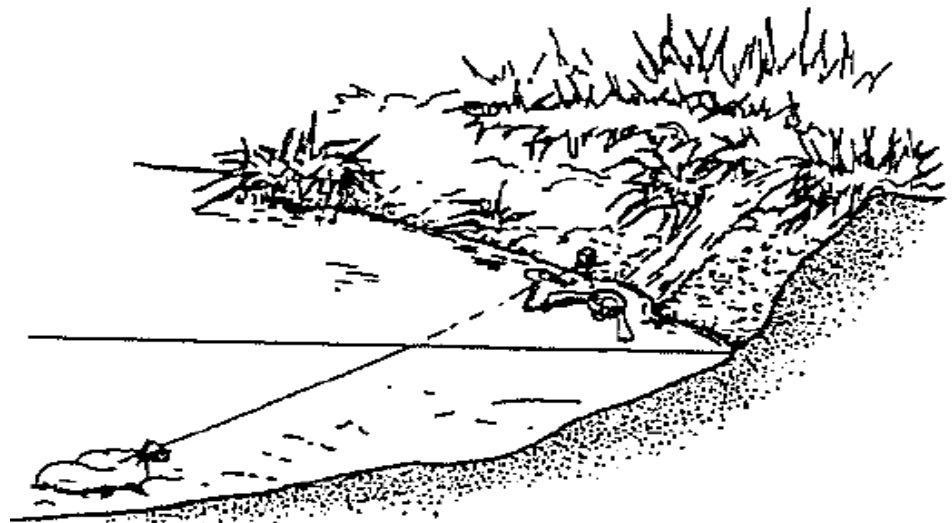

A mesh nylon bag, like a sand bag, can be filled with rocks, sand, gravel, or dirt from the set location and used as an anchor in deep water. It should weigh at least 10 pounds for raccoon and 20 pounds for beaver.

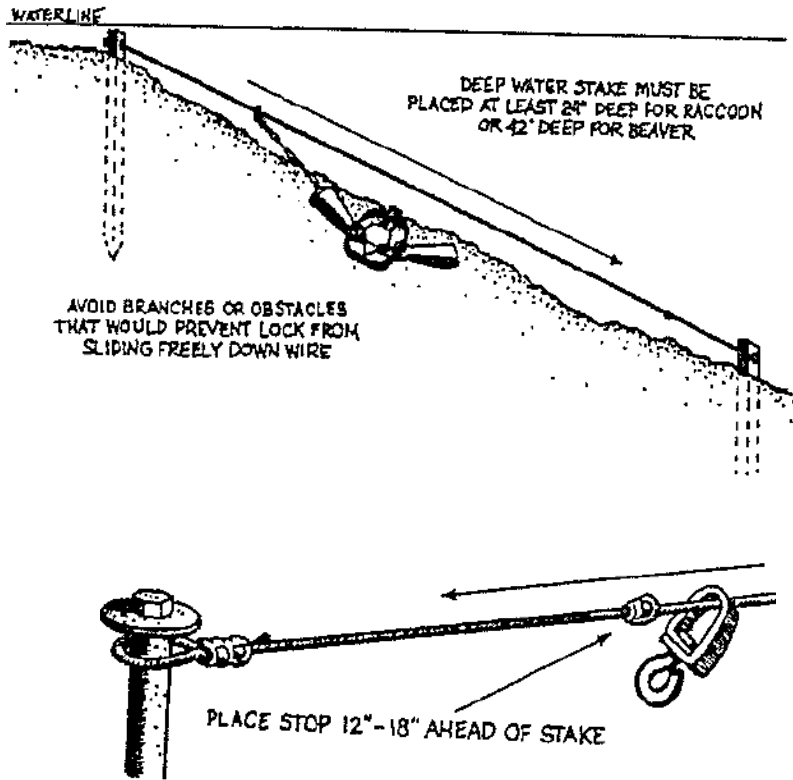

BAITS, LURES, AND SCENTS

Trapping without baits, lures, and scents is like fishing with a bare hook. Generally speaking, lures and scents attract an animal to a set whereas baits keep them occupied until they are captured.

Remember that all baits used for land sets must be hidden from sight or placed at least 30 feet away from your trap.

Trapping supply dealers sell many brands of lures. Most of them work well, but some are better than others. We recommend experimenting with different kinds of lures and letting experience guide future purchases.

Food lures appeal to the animal's hunger. Most lures fall into this category. Lures made from the glands of animals that you are targeting usually work best during the mating season. At this time, animals are actively seeking out others of their kind and will be drawn to lures that promise an encounter.

Equipment checklist for water sets:

Hip boots (chest waders if you are trapping around deep water)

Gauntlets (long rubber gloves).

Long-handled trowel or narrow shovel

Wire

Stakes

Hammer or hatchet for driving stakes

Drowning slide wires

Trap setting tongs and safety catch

Trap basket, 5-gallon bucket or gym bag

Plastic flagging

Lure and/or bait

Spare trap tags

.22 caliber gun for dispatching animals

Pliers, with a side cutter for cutting wire

Change of clothes (especially important in the cold weather)

Some suggested baits include:

Muskrat - Part of an ear of corn, apple, or potato.

Mink - Chunks of fish or muskrat (fresh).

Raccoon, Opossum - Chunks of fish or muskrat (fresh); used eggs, marshmallows, hard candy, fruit or jam, sweet breakfast cereal or peanut butter where pets are present.

Beaver - Twigs or sections of branches from willow, maple, and wild cherry trees.

Coyote, Fox, Badger - Small chunks of muskrat or beaver meat (fresh or tainted); baits sold by trapping supply dealers.



Pre-season scouting can be done during other outdoor activities. Curiosity lures cause animals to investigate a set because they smell something strange or different. Using skunk essence, shellfish oil or beaver castor at a fox set is an example.

Urine is considered a scent. Like most canines, foxes and coyotes use urine to mark their territories and readily investigate smells that suggest a stranger has passed through. Purchasing high-quality urine from a reputable trapping supply dealer will allow you to capitalize on this behavior.

BEFORE THE SEASON

For most species, the trapping season lasts only 60-70 days per year. Pre-season scouting can help you make the most of the time that is available. Some things you can do before season include:

- Getting permission from landowners.
- Finding the best set locations.
- Planning a route for your trapline
- Estimating the number of sets you will need to make in each area.
- Storing heavy or bulky items at set locations.

Some people prepare and bait their sets one or two weeks before the season. This saves time on opening day and allows animals to get accustomed to visiting set locations. Remember that you cannot carry or set traps in the field until the season opens.

The amount of pre-season work required for your trapline is determined by its size. A day or two is probably plenty if you are trapping only on your own property. A month or two might be better if you operate a large trapline, especially one that is spread over a long distance and many properties.

Keep in mind that pre-season “work” can be enjoyable as well as productive. For example, you can combine many activities with trips taken to hunt, fish, dig ginseng, pick wild mushrooms, cut trap stakes, or help a landowner who gave you permission.

WATER SETS

Bank hole set

Muskrat and beaver dig underwater entrances to their dens. As animals swim in and out, they wear runways in front of the entrances. Locate runways and set body-gripping traps. You can set more than one trap per runway if it is long and well defined, but space them out so that a captured animal does not trigger nearby traps.

Entrances are easy to spot when a thin layer of clear ice forms on a pond or lake. Air bubbles exhaled by animals or caught in their fur get trapped beneath the ice and lead you to the entrance. Beavers usually place some sticks and mud over their dens when repairing them. The entrances will be nearby.

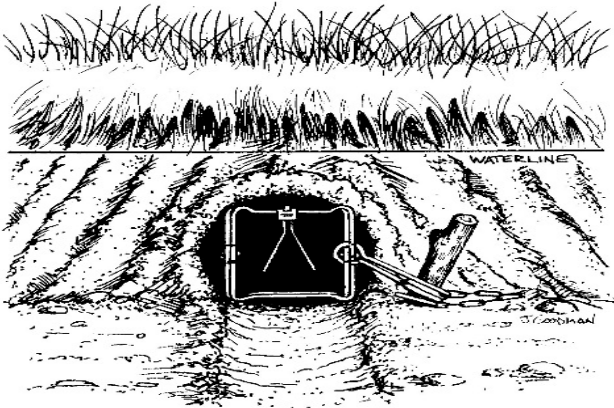

Channel set

Muskrat, mink, and beaver follow underwater channels as they swim along the bottom of streams and creeks. You can take advantage of this behavior by setting body-gripping traps in likely locations. Use sticks, brush, or rocks to narrow natural channels that are wider than your traps.

Beaver sometimes excavate channels that lead from the main waterway to a stand of trees. These are excellent locations.

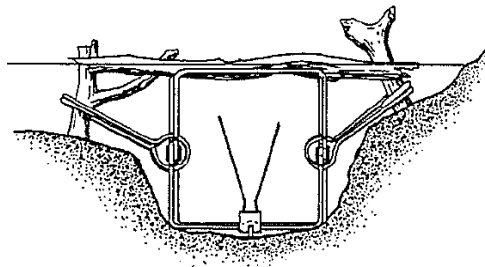

CAUTION:

Runways that lead to beaver dens can be as much as four feet deeper than surrounding water.

Be extra careful when walking on the ice near beaver dens, their activity keeps it thin even in the coldest temperatures.

When making water sets, you can set traps as close to the den entrance as you want. Remember that traps set on land must be at least 10' away from the den entrances.

CAUTION:

Use guarded foothold traps for trail sets when targeting muskrats in areas with swallow water. Extension wires, tangle stakes, or slide-wire drowners can be used if deep water is nearby.

Always use slide-wire drowners when targeting beaver with foothold traps.

Raccoons and muskrats share the same types of habitat. Remember to always anchor your traps to hold the largest potential catch.

Sloping trail set



Trail set

Muskrat and beaver wear trails as they travel back and forth from water to food sources located on the bank. Foothold traps can be placed underwater where animals approach the trail. For short-legged animals like muskrat and beaver, position the traps so that animals step between the jaws rather than over them.

For muskrats, you can make a trail by rubbing your boot back and forth up the bank, then applying some fresh mud from the stream bottom. This has the same appeal as a natural trail but allows you to make sets where it is convenient or where you have access to deep water for drowning your catch.

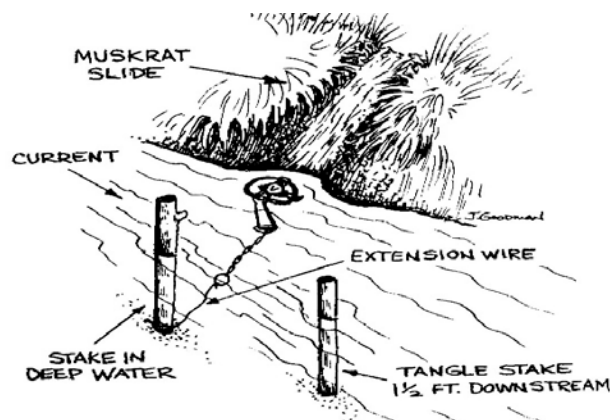

Mink tend to follow trails that run parallel to the bank. They are less noticeable than trails made by muskrats or beaver. However, you can sometimes detect a narrow path through grass or weeds.

The best way to start looking for trails used by mink is to image a path of least resistance (a route with the fewest obstacles). Like most animals, mink tend to choose the easiest route.

Once you locate a path, set a body-gripping trap. If necessary, use stems from grass or weeds to guide the mink through your trap while helping to conceal its outline. A few well-placed stems will get the job done – do not over do it. Remember that mink are slender animals, capable of slipping through a #110 or #120 trap without triggering it. Some ways to avoid this problem include using the proper trigger configurations, fastening a piece of monofilament between the tines of the trigger, or using the smaller #55 or #60 models of body-gripping traps.

Lodge and feed bed set

In some areas, muskrats build lodges out of vegetation. The front of the lodge usually has one or more “ramps” that slope gradually toward the water. Set foothold traps at the bottom of the ramps. Also check the back of lodge (steep side) for a small hollowed out area where muskrats stop to feed or rest. “Feed beds” are piles of cuttings that build up when muskrats make a habit of carrying their food to the same location to eat. Like lodges, they can be very productive locations.

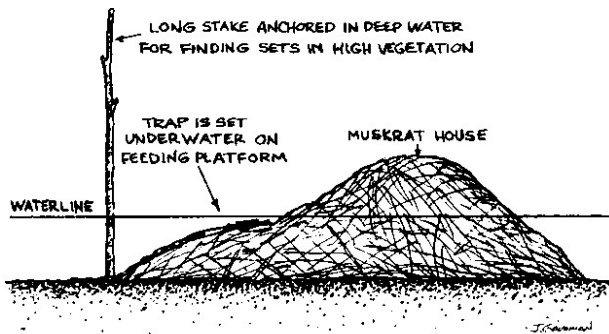

Float set

Muskrats climb up on floating logs and other objects that provide a dry spot to groom, feed, and rest. Float sets take advantage of this behavior and use bait for added attraction. Many different designs have been used successfully.

Obstruction set

Animals traveling along the bank are sometimes forced to enter the water by an obstruction like a tree, large rock, root wad, or clump of dirt. These natural “funnel points” make excellent set locations, even without bait or lure. Use either foothold or body-gripping traps. Your choice will probably depend on the type of obstruction and depth of water next to it.

For mink, position the trap as close to the obstruction as possible. Set foothold traps no more than 1-2” under water. Placing a “guide stick” next to the outside edge of the trap can help to direct a mink over the pan. The guide stick should extend 2-4” above the water. A twig about the diameter of a pencil lead will be plenty. For raccoon, the trap pan should be 3-6” from the side of the obstruction. A heavier guide stick can be used if desired.

Float set

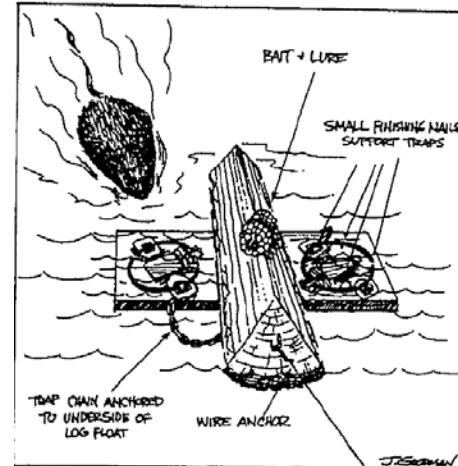

CAUTION:

Do not use corn for bait in areas where waterfowl are present. Instead, use lure or place a handful of fresh mud on the float. You can also discourage waterfowl by making a “roof” over the float with a piece of chicken wire.

Obstruction set



Pocket set

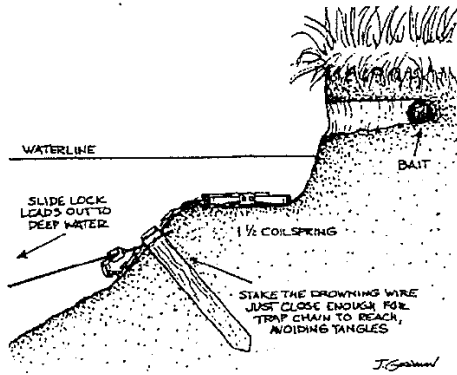

MINK POCKET SET

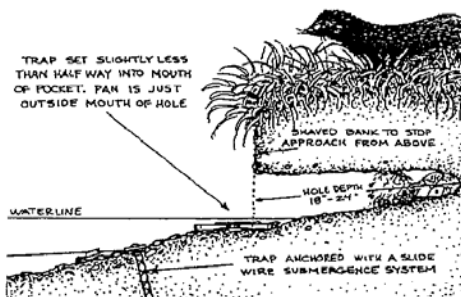

Pocket set

Pocket sets are one of the most popular water sets because they are effective and easy to construct. Trap placement is important. For mink, the trap should be set half way inside the opening of the hole. For raccoon, set the trap 3-6" in front of the opening. Trying to split the difference will not improve your catch of both species.

Many variations of the pocket set have been described in books and magazines articles. They operate on the same principle but offer advantages in some locations.

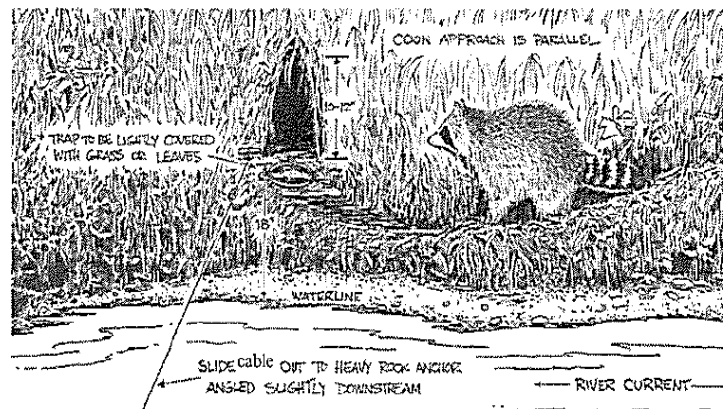
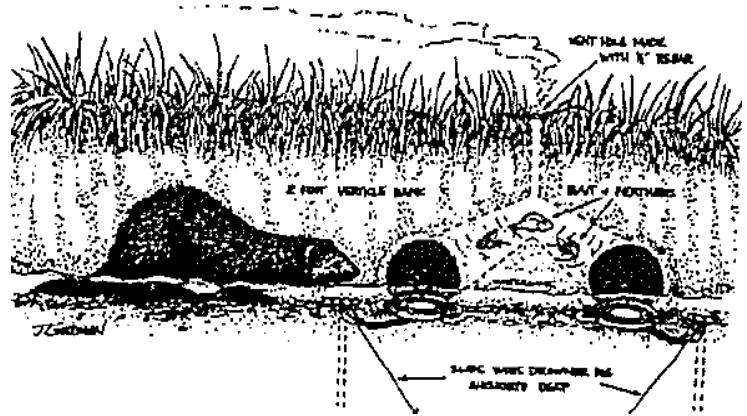

Pipe set

The pipe set is a good choice for waterways with flat, featureless banks. It is also an efficient set because it allows you to choose your set locations rather than look for natural ones.

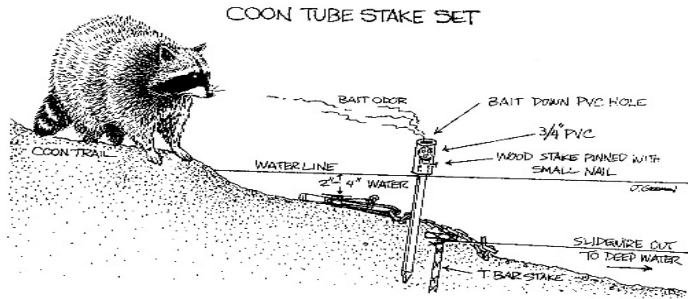

Baited under-ice set

Bank hole and baited sets are about your only choices for capturing beaver when a waterway is covered with ice. While baited sets are less efficient, they have a place on the trapline, especially when bank holes are hard to locate, blocked by debris, or too dangerous to set because of thin ice over the runways.

These sets are most effective late in the winter, when beaver's food cache is stale – your fresh bait will look appealing by comparison. Make baited sets near food caches where beaver will encounter them.

Castor mound set

During the spring, beaver mark their territories with castor mounds. They make the mounds by scooping mud, leaves, and other debris off the bottom. They carry it up the bank and deposit their scent (castoreum) on it. Sets can be constructed at natural castor mounds, or you can make your own with a few scoops of mud and some lure.

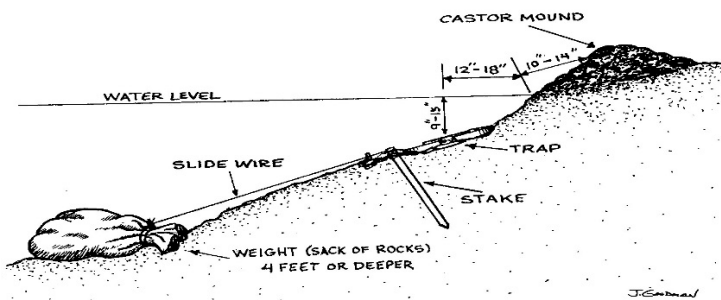

Baited under-ice sets:

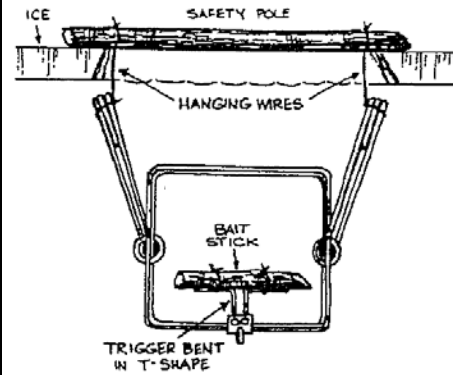

J.T. GOODMAN '98

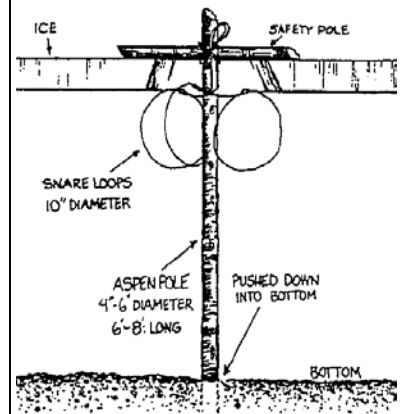

If an animal is frozen in a body-gripping trap, thaw it before removal to prevent fur damage.

Caution:

It is unlawful to disturb, molest, or destroy a beaver dam while trapping. Body-gripping traps with a jaw spread larger than 7"x7" must touch the water.

Dam crossing set

Beaver spend most of their time on the upstream side of a dam. However, they cross the dam often enough to make this a good set location.

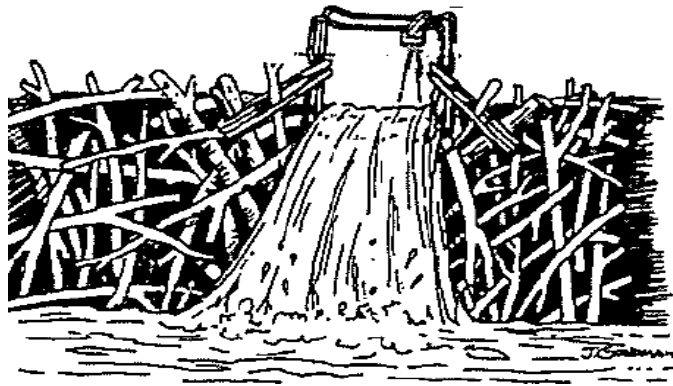

LAND SETS

Baited cubbies

“Cubbies” can be made from plastic buckets or pails, wood, wire mesh, or corrugated drain tile. While bulky, they work well for capturing raccoon and opossum.

Proper design is a must for avoiding the capture of pets. Two approaches are popular; One involves recessing the trap at least 8” from the entrance of the cubby, the other approach is to restrict the opening of the cubby with a wire extension.

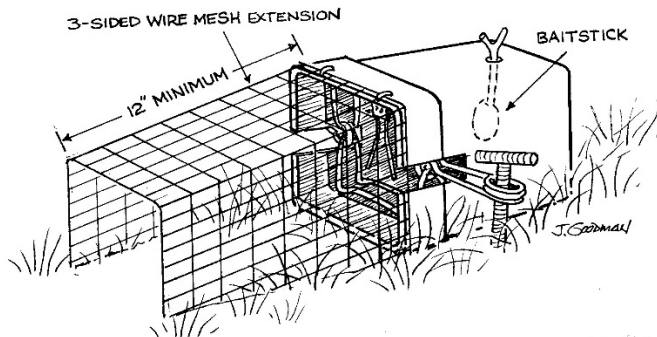
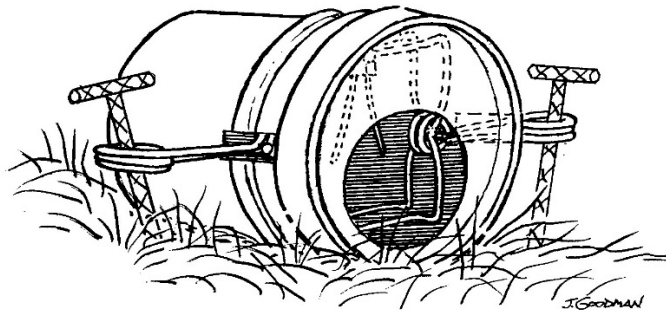
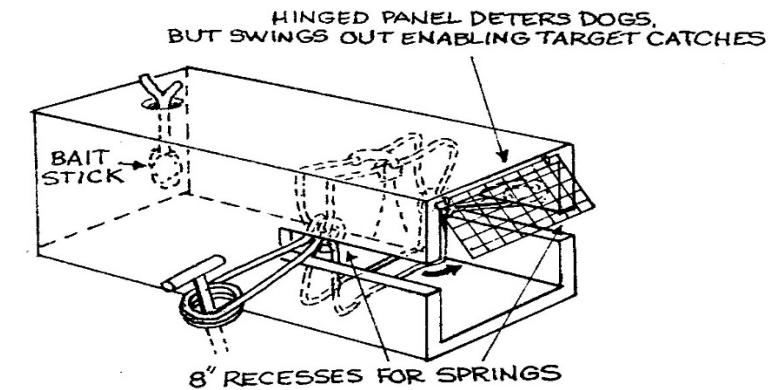

CAUTION:

Never make these sets where pets are present or likely to travel.

Use sweet baits like marshmallows, peanut butter, hard candy, molasses, or breakfast cereal to further discourage pets from investigating cubbies. The same applies to lures.

A cage trap is a self-contained cubby. It is the best choice for targeting raccoon and opossum in areas where pets are present.

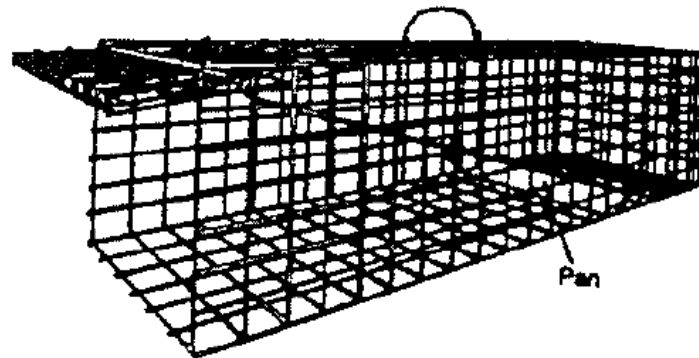

CAUTION:

Never make trail sets where cats or dogs are present or likely to travel. Always use a wire mesh cover (approximate size shown to the side).

Trail set – body-gripping traps

Trail sets made with #160 or #220 body-gripping traps are effective for capturing raccoon and opossum. No baits or lures are needed.

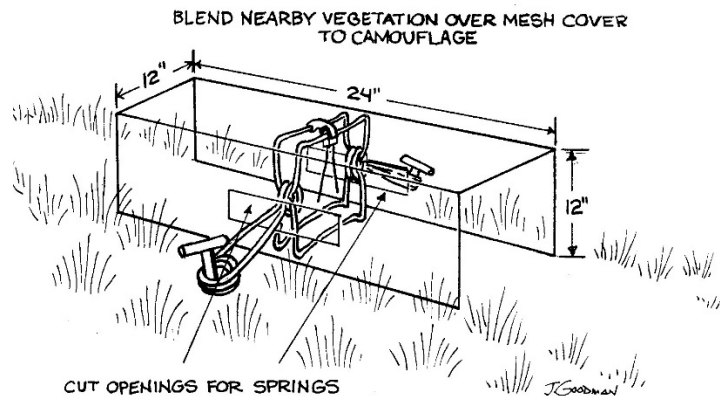

Bedding foothold traps

“Bedding” refers to the process of stabilizing a trap so that it does not wobble when an animal steps on it. This is very important when you are targeting fox or coyote.

Step 1. Dig a hole slightly larger than the outside profile of the trap. The depth will depend on the amount of chain you need to conceal under the trap – the longer the chain, the deeper the hole. When the set is finished, the top of the trap should be covered by $\frac{1}{8}$ ” – $\frac{1}{2}$ ” of soil, and the pan should sit slightly lower than the ground around it.

Step 2. Test the hole to make sure your trap will fit; make adjustments if needed. Position and drive your stake at the front of the hole (the side nearest to you) where the loose jaw of the trap can rest on it.

Step 3. Place the trap chain in the bed; cover it with soil, and pack it with your hand or fist.

Step 4. Place the trap in the bed with the loose jaw resting level on the top of your stake. Twist the trap slightly from side to side to settle it in the dirt.

Step 5. Pack dirt tightly around the outside of the trap (except for the spring levers).

Step 6. Use your finger to apply pressure to each jaw and spring lever (one at a time). If you detect movement, add some soil or a small dirt clod under the low spot.

Step 7. Put a cover over the pan. Sift dirt over the trap until it is nearly level with the top of the bed.

Step 8. Locate the pan by brushing away some of the dirt. When you know where it is, pack dirt around the outside of the pan using the palms of your hands.

Step 9. If needed, brush or shift a fine layer of dirt over the set to blend it in with its surroundings.

Step 1

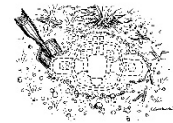

Step 2



Step 3



Step 4



Step 5



Step 6



Step 7



Step 8



Step 9

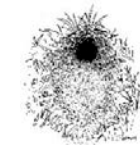

Dirt-hole set

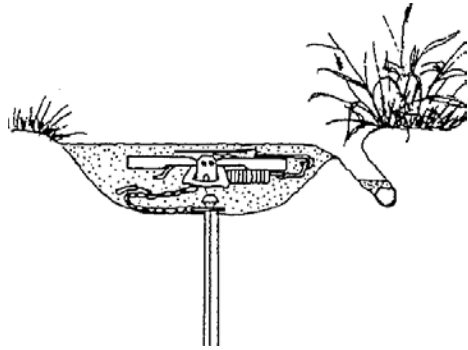

CAUTION:

These sets are attractive to all predators, including domestic dogs. Do not make these sets near houses where pets are present. Use padded foothold traps in areas where dogs are allowed to roam free and areas used by hunters with dogs.

Remember that bait must be concealed completely from sight (placing the bait in the bottom of the hole usually meets this requirement).

Flat and scent-post set

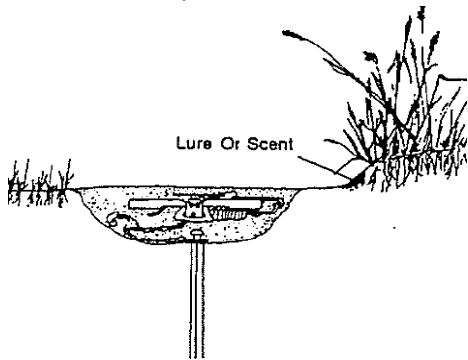

Dirt-hole set

Red fox often store uneaten food by burying it. All predators investigate these “caches” because they promise a free meal. The dirt-hole set imitates a food cache and can be used to target a wide range of species depending on the set location and type of lures and baits you select.

Dig the bait hole in front of a natural obstacle like a clump of grass or place a rock or dirt clod behind it to help direct an animal’s approach to the front of the set.

Step-down set

This is a variation of the dirt-hole set. Setting the trap in a shallow trench that extends in front of the dirt hole helps to direct the animal’s approach so that it steps squarely on the pan. The same cautions apply to this set.

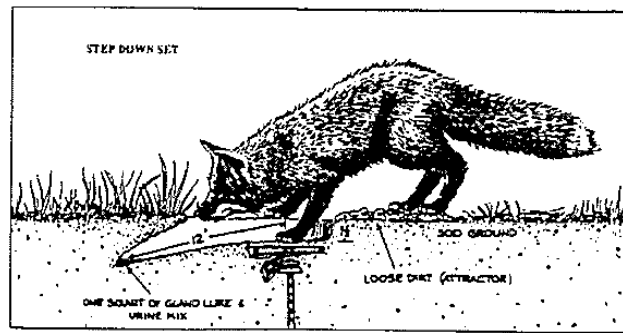

Flat and scent-post sets

Flat sets are made with a food lure and attract a wide range of species. Scent-post sets are nearly identical but use gland lure or urine to better target fox and coyote.

Walk-through set

This is a variation of a dirt-hole or flat set. Loose dirt or vegetation (like soybeans hulls and stems left after harvest) guide an animal's approach. This set comes in handy for re-makes (setting the same location after a catch is made) because odors and torn vegetation left by the first catch can be used to your advantage.

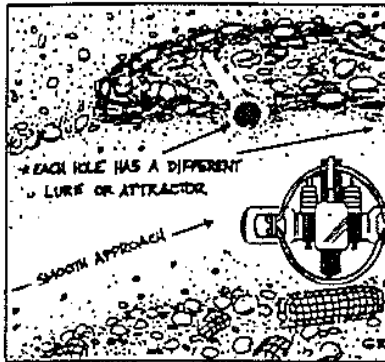

Trap placement

Trap placement is a matter of choice, but a good rule of thumb is 12" when targeting coyote and 7" when targeting red fox.

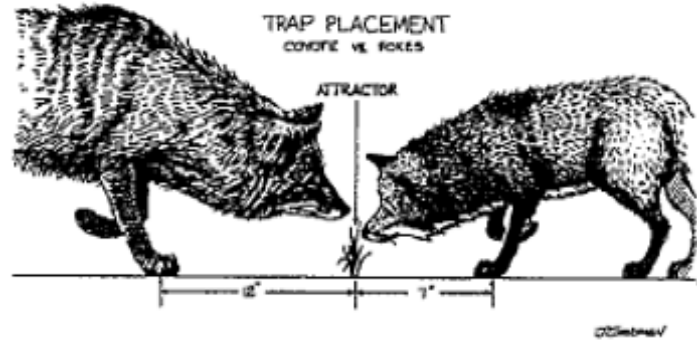

CAUTION:

These sets are attractive to all predators, including domestic dogs. Do not make these sets near houses where pets are present. Use padded foothold traps in areas where dogs are allowed to roam free and areas used by hunters with dogs.

Remember that bait must be concealed completely from sight (placing the bait in the bottom of the hole usually meets this requirement).

Padded trap set

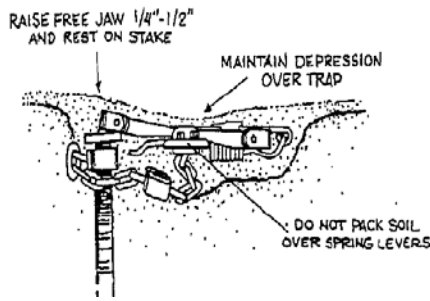

Some trappers prefer to install an extra set of coilsprings (four-coiling), especially if they make sets in areas with heavy soil that tend to slow the closing speed of the jaws when the soil is wet or frozen.

Tips for using padded foothold traps

Manufacturers installed weak coilsprings on early prototypes of padded traps because they reasoned the modification would help to reduce injuries. Weak springs allowed enough animals to escape during field tests that it earned the padded trap a poor reputation. While manufacturers corrected this problem in later models, trappers' perceptions of the padded trap were slow to change.

Today, padded traps have standard coilsprings or come from the factory already "four-coiled." Scientific research shows that it is a combination of padded jaws, a short chain, and a shock spring that reduces injuries regardless of the strength of the coilsprings. Just as importantly, modern padded traps catch and hold animals every bit as well as standard traps when set properly.

Tip for land trapping

Sooner or later, you will encounter a fox or coyote that digs up your traps. This behavior can be caused by a trap that is not bedded solidly. As the animal approaches your set, it feels the trap move beneath its foot and investigates by digging. See page 37 for suggestions on bedding a trap properly.

Another possible cause is that the animal smelled a foreign odor (usually lure) on the trap, pan cover, or dirt. To avoid contaminating your traps with lure, carry them separately. Also carry two sets of gloves; one used only for handling traps and the other for handling lures. If you suspect that your traps are contaminated, boil and re-wax them to remove the odor.

CHECKING TRAPS

By law, all traps must be checked at least once each calendar day. We recommend checking foothold traps early in the morning. Advantages include the following:

- Furbearers are most active at night. Early-morning checks help to minimize the time they spend in traps, thereby reducing stress and injuries.
- People are most active during the day. Removing your catch early in the morning can help to reduce thefts.
- The longer an animal is trapped, the more likely it is to escape. Early-morning checks help to increase your total catch.

Some other tips for checking traps:

- Before leaving the house, make sure all your equipment is accounted for and in good working order.
- Set only as many traps as you can check comfortably in the time you have set aside.
- Set body-gripping traps if your schedule does not allow for early-morning checks.
- Approach sets closely enough to determine if the trap has been triggered without a catch. Keeping sets in working order will improve your success.
- Learn from trap checks – an animal’s tracks will help you to understand its behavior when approaching a set and make adjustments that improve your catch.

KILLING TRAPPED ANIMALS

Nearly everyone agrees that animals should be killed as humanely as possible. However, their ideas about a particular method might be quite different. Some people believe that guidelines developed by the American Veterinary Medical Association (AVMA) should be followed when killing wild animals in the field. We believe, as does the AVMA, that standards developed for veterinarians are not necessarily applicable or appropriate for activities like hunting and trapping.

Licensed veterinarians can use lethal drugs that are not available to the general public. They have more control over animals and do not need to worry about chemicals that make meat unfit for human consumption. While these limitations explain why methods used to kill animals on the trapline differ from those used to kill animals in a laboratory or clinic, you have the same obligation to kill animals as quickly and painlessly as possible – for their sake and yours.

The best way to kill a live raccoon, coyote, fox, opossum, or badger is a well-placed shot to the head with a .22 rimfire cartridge. Before firing, check for solid objects like rocks that might cause a ricochet if you miss. Anyone who comes with you should stand well behind when a shot is fired. For more complete overview, we suggest that you attend one of the IDNR’s Hunter Safety courses. Successful completion of this course is required for all first-time hunters born on or after January 1, 1980.

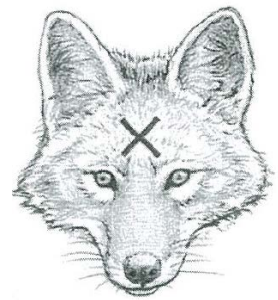

Joe Goodman

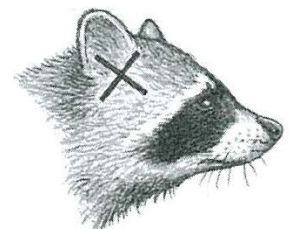

Joe Goodman

Shot placement is important for a quick, humane kill.

Tips for handling fur on the trapline

Do not lay wet animals in the bed of a pickup when temperatures are below freezing – their fur will stick to the metal.

If you have room, put a pallet in your truck or boat; place your catch on the pallet to keep it out of puddles and allow air to circulate.

When available, snow makes a great material for washing and drying fur – scoop snow over the animal, rub it into the fur, then shake it out.

Opossums have small brains located low in the head, so they should be shot at the base of the ear or through the midline of the skull. Skunks tend to spray when shot in the head (direct contact with your eyes can cause temporary blindness). Approach slowly from upwind and talk in a soft, monotone voice if a skunk raises its tail before you can get close enough to shoot accurately. Aim for the heart, just behind the front leg between the elbow and shoulder.

Striking an animal sharply on the skull with a hardwood club or metal pipe is effective for small mammals like muskrat or mink. You can tell if the animal was killed instantly or is merely unconscious by touching its eye. An animal that is unconscious will blink. If it does, you should strike the animal again or use another method to kill it.

Using body-gripping traps can reduce the need to kill animals directly. However, these traps are effective only for capturing raccoon, opossum, skunk, muskrat, mink, and beaver. Using drowning slide-wires or tangle stakes are options for killing animals captured in foothold traps near water - usually raccoon, muskrat, mink, and beaver.

For some people, killing an animal can be an unpleasant task, even when done properly. We suggest that you take time to examine your feelings about this issue and choose another outdoor activity if it makes you uncomfortable.

FUR HANDLING

On the trapline

Making the most of your catch is one of the many responsibilities that comes with trapping. Proper handling begins on the trapline.

Animals caught near water should be washed. Holding the animal under water, run your free hand back and forth over its entire body to remove dirt and blood. If you are wearing hip boots or chest waders, hoist the animal onto your knee and use a free hand to “squeegee” away excess water, working from head to tail. Small furbearers like muskrat or mink can be held by the head and given a quick snap of your wrist to remove excess water. Never place animals in a pile. It can trap body heat that causes them to spoil.

Animals caught in land sets can be transported to water and treated the same way if necessary. Those captured in body-gripping traps are usually clean and free of blood. Animals caught in foothold traps are usually clean unless rain creates muddy soil conditions. Any blood that soaks into the fur when you shoot an animal should be washed away before it dries, or it can matt and stain the soft underfur.

At home

Drying the fur completely makes it easier to handle. Large animals like raccoon or coyote should be hung by a front foot in a cool, dark place. Use a fan to speed the drying process if temperatures are warm (above 40 degrees) or the humidity is high. After the fur is dry, use a fur comb (also called scotch comb) to remove burrs and heavy dirt. Use a grooming brush (also called slicker brush) to finish long-haired furs like fox.

Marketing whole animals

Animals that are marketed whole (also called “in the round”) should be sold daily if temperatures are much above 40 degrees. As a rule of thumb, they can be stored for 2-3 days if hung in the shade and temperatures stay below 40 degrees. Muskrat, fox, and coyote are more prone to spoil than raccoon, opossum, mink, and beaver.

Whole animals can be frozen if you have the room. Make sure that they are clean and dry before placing them in the freezer. Animals that were killed recently should be allowed to cool long enough to let their body heat escape before placing them in the freezer. Small animals should be wrapped individually in sheets of newspaper. Place newspaper or cardboard between animals that are too large to wrap.

Before taking them to a fur buyer, remove them from the freezer and allow them to partially thaw. Large animals that are frozen whole will require 24-48 hours to thaw at 65 degrees; smaller animals need at least 8-12 hours.



Properly caring for fur avoids waste and adds to its value. Pelts should be dry and free of dirt, blood, and burrs when they are sold.

Never seal animals or pelts in plastic bags when freezing them. The bags trap heat and moisture that can damage the fur.

Fur is a great insulator. Piling animals or pelts in a freezer can cause those in the middle to spoil. Place animals in a single layer. If you have too many, rotate animals from the middle of the stack to the outside after 12-24 hours.

Never lay animals or pelts on bare concrete to dry or thaw because it holds moisture that can cause them to spoil.

Never place animals or their pelts near a heater to dry or thaw.

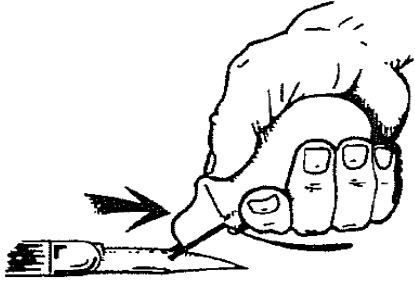

Keeping your knives sharp will allow you to make cleaner cuts and fewer mistakes. A carbide-tipped sharpener is handy for removing nicks and getting a rough edge on the blade.

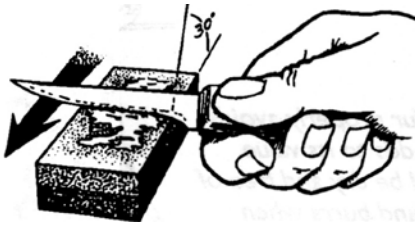

Use a whetstone or sharpening steel to put a fine edge on the blade.

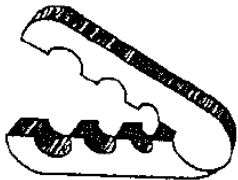

A “tail-stripper” comes in handy for removing the bone from the tails of coyote, fox, raccoon, mink, skunk, and weasel.

Skinning

Skinning animals takes time, but it has some advantages:

- If you have limited freezer space, pelts take up less room than whole animals.
- Most dealers pay more (25 cents - \$1 depending on the species) because it saves them the cost of having someone skin your catch.
- Meat from some furbearers can be used as bait or marketed for human consumption.
- You can tap into secondary markets for glands, skulls, teeth, and claws.

You will need some basic equipment for skinning. A sharp, high-quality knife is a must. Blades with pointed tips are best, except when skinning beaver – rounded tips come in handy for this job. Blades with serrated edges are not recommended unless you want to keep one handy for occasional use on the head or other areas where frequent contact with bone can quickly dull a regular blade.

There are two ways to skin furbearers: cased or opened. The cased method involves making a cut from heel to heel and around both ankles, then pulling the hide over the animal’s head like you would remove a tight glove or sweater. The open method involves making a slit in the belly skin from the chin past the vent.

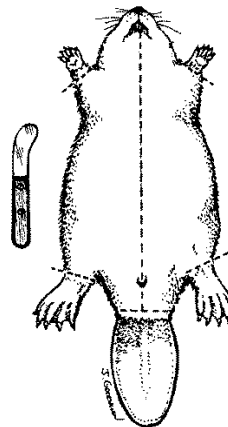

Beaver is the only furbearer in Illinois that is skinned open, then stretched and dried by nailing its pelt to a board.

Case-skinning muskrat

Muskrats are among the easiest furbearers to skin because the connective tissue that joins the pelt to the muscle is weak.

Some trappers prefer to hang the animal from a gambrel; others feel this is a wasted step. If you use a gambrel, poke the top of one hind foot through a hook. The cutting edge of your knife should face upward and angle away from you, just under the skin. Grasp the tail and make a cut from the base of it (where the fur ends) to the heel of the hind foot that is held by the gambrel. Repeat on the other side.

Make cuts around the ankles of both hind feet. Some people make cuts around the wrists of both front feet, but this is not necessary. Make a cut completely around the base of the tail where the hair ends.

Work the skin free from the muscle tissue on one of the hind legs. After it is started, push your forefinger and index finger under the pelt toward the backbone, then upward under the tail, pulling the pelt free. Peel the skin away from the muscle all the way across the cut. Follow through with your thumb around the leg bone and start removing the pelt on the animal's belly side.

Pull the pelt downward toward the animal's head. It should come off freely until you get to the front legs. Pass a finger between an armpit and the pelt to loosen it, then pull downward until the front leg comes free. Repeat this on the other side.

Grasp the pelt at the tail end and pull downward until it stops at the ears (you will notice some whitish cartilage where the ears connect to the skull). Make small cuts to separate the base of the ears from the skull. Pull downward until you get to the eyes. Use a knife to make small cuts that separate the eyelids at the skull. Pull downward until the pelt is free or make a small cut at the tip of the nose.

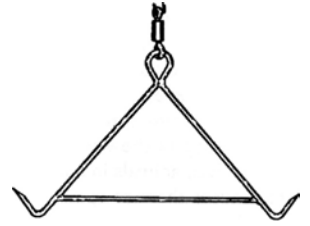

A gambrel is used to hold animals in position for case-skinning



Initial cuts for case-skinning muskrat and opossum. The tail remains attached to the carcass, not the pelt.



Initial cuts for case-skinning fox, coyote, bobcat, and otter. The tail stays attached to the pelt.

Take health precautions while skinning

Some furbearers carry diseases and parasites that can be passed on to humans during the skinning process. To avoid health threats:

Use a bandage to cover open cuts and sores on your hands before skinning wild animals

Wear latex gloves.
Disposable latex gloves, like the ones used by surgeons, are available from pharmacies or trapping supply dealers.

When finished skinning, wash your hands well with antibacterial soap.

Do not handle drinks, food, etc. during the skinning process. It can pass bacteria to your mouth.

Case-skinning raccoon

Make cuts around both ankles and wrists. Some people prefer to cut both front feet off at the wrists with a hatchet. Next, make a cut from the inside of one heel to the other, passing below the vent. Grasp the end of the tail and split the underside toward the vent. If you have a tail-stripper, you can start the cut about 4-6" from the base of the tail. Continue the cut along one side of the vent until it meets the cut that goes from heel to heel. Make a cut on the other side of the anus, forming a triangle around the vent.

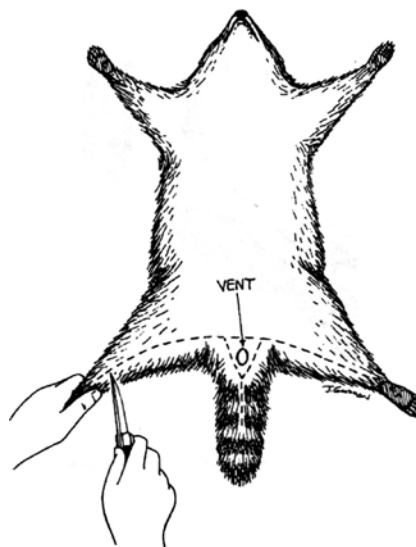

Using your knife, separate the pelt from the muscle around both ankles. You will need to loosen enough of the pelt to grab it. Pull downward with some force. This should separate the pelt along most of the leg. Repeat this procedure on the other side.

Work the pelt free near the base of the tail. If necessary, cut some of the connective tissue. Peel the pelt away from the tailbone for a distance of 4-6". Place a tail-stripper around the tailbone and yank downward with one hand while using your other hand for leverage against the lower back of the raccoon. If the tailbone does not pull out, extend your cut a few inches toward the tip of the tail and try again. Split the tail all the way to tip after the bone is removed.

Pull the base of the tail toward you and run your fist downward between the pelt and the muscle tissue along the backbone. Turn the animal around and loosen the pelt from the belly. If the raccoon is a male, the skin will stop at the tip of the penis; a small cut can be used to separate it from the pelt.

Run your fist downward between the pelt and the muscle tissue along the centerline of the belly. Pull the pelt downward, freeing the sides. It will stop at the front legs. Using a knife, make a slit through the connective tissue at the shoulder and upper arm. Be careful not to cut through the pelt itself.

Loosen the pelt near the armpit by pushing between the pelt and muscle tissue with your fingers. After it is started, cup your fingers from both hands through the opening and pull downward. This should separate the pelt to the wrist, where it will pull free. Repeat this procedure on the other side.

After both front legs are free, pull downward on the pelt. The pelt of young raccoons will usually separate to the base of the skull. The connective tissue on the necks of older raccoons is stronger. You will probably need to use a knife in some places but be careful. A light touch with a sharp blade will get the job done, especially if you are applying pressure to the pelt by pulling it downward.

Continue working the pelt downward until it stops at the cartilage that forms the base of the ears. Cut through the cartilage at a point close to skull. When both ears are free, pull downward until you reach the eyes. Using a knife, separate them from the pelt by cutting carefully next to the skull. Pull downward again to the tip of the nose and make a small cut through the cartilage to free the pelt.



Tails remain attached to the pelts of raccoon, fox, coyote, mink, weasel, otter, bobcat, and skunk. After removing the bone, split the tail along its entire length. Using a guide can help you to make a straight cut.



Step 1.



Step 2.

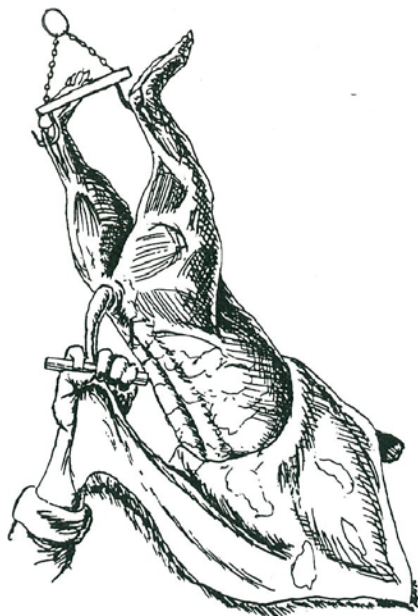

Step 3.



Step 4.

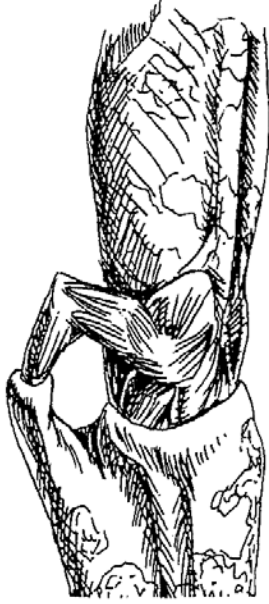

Step 5.



Step 6.



Step 7.



Step 8.

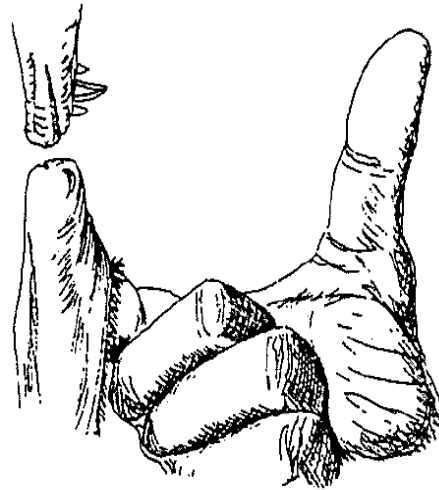

Step 9.

Tips for freezing skinned pelts

Turn the pelt fur side out and match the belly to the back so that the leather side of the pelt is less prone to freezer burn.

If the pelts have tails attached, flip the tails under the belly, wrap the pelts in newspaper and lay them flat in the freezer.

Never wad or roll up pelts to freeze them; the inside can spoil.

Never freeze skins inside sealed plastic bags, they will collect moisture that can damage the fur.

Remove muskrat, mink, and fox for at least two hours before you take them to a fur buyer, they should still be "frosty".

Remove raccoon, coyote, beaver, and otter pelts from the freezer about 6 hours before taking them to a fur buyer; they will be partially frozen.

Never thaw pelts by laying them next to a heater or fire.

Open-skinning beaver

Make cuts as shown earlier in this manual. Be careful not to cut into the muscle tissue. Insert your blade just beneath the skin with the cutting edge facing up and angled away from you. We recommend removing all four feet with a hatchet or heavy-duty knife.

Beaver have a thin layer of fat between the pelt and muscle tissue on the belly. Starting at the edge of the cut you made down the beaver's belly, use a round-tipped knife to separate the pelt and fat from the muscle tissue. Continue this process along the entire length of the beaver. Take your time and angle your blade toward the muscle tissue to avoid slicing into the leather.



You will encounter a thin layer of connective tissue about half way between the centerline of the belly and the legs. Cut through it, leaving the connective tissue attached to the pelt. Continue separating the pelt until you reach the armpit and groin area. Pull the pelt back to expose the layer of connective tissue around the legs. Slice through the tissue, then run a couple of fingers under it along the legs. You should be able to flip the pelt over the end of the bones where you cut off the feet.

Flip the beaver on its side and continue separating the pelt from the muscle tissue, working toward the backbone. You will probably need to cut into the muscle tissue near the lower hip and tail, leaving some of it attached to the pelt. The middle part of the pelt will separate easily by pulling it back or running your hand between the pelt and muscle. Do not worry about skinning out the shoulders and neck at this point. Lay the beaver on its back and repeat these procedures on the other side.

After the pelt is loose on both sides, lay the beaver on its belly and flip the pelt over the beaver's head. This exposes the shoulders, which can be separated easily from the pelt. Continue working toward the head until you encounter the ear canals at the base of the skull. They are somewhat bony and connected by cartilage. Cut through the cartilage at the skull and continue skinning out the head. You will need to make some cuts to separate

the connective tissue around the eyes and another when you get to the tip of the nose.

Fleshing pelts

Fleshing removes fat and muscle tissue that can spoil and damage the pelt. Muskrat, mink, river otter, weasel, fox, bobcat, and coyote are relatively easy to flesh. Raccoon, beaver, opossum, badger, and skunk are more difficult.

Muskrat

For muskrat, you will need a fleshing board and a scraper. You can make a fleshing board from a piece of 1" x 6" lumber. Cut it to the shape of a wire stretcher but not as wide. Use a rasp to round the edges, then sand them smooth.

Turn the pelt so that the leather side faces out and pull it over the rounded tip of the fleshing board. Rotate the pelt until the sides are on the flat working surfaces (one of the holes from a front leg should be on the front, the other on the back). Pull the pelt downward until it is snug.

Using a one-handed scraper, serving spoon or dull knife, remove any chunks of fat or muscle from the skirt (bottom) of the pelt. Next, remove any muscle tissue attached to the pelt near the cheeks. Well-fed muskrats have a fat deposit under each armpit. Remove those, along with the reddish membrane that covers them.

Over-scraping is usually more of a problem than under-scraping with muskrats. If you apply too much pressure, you will tear a hole in the pelt. Small specks of fat are not a problem because they will dry out when you put the pelt on a stretcher. It is the larger chunks and deposits under the armpits that need attention.

Mink, weasel, and river otter

Place the pelt, leather-side-out, on a wooden stretcher. Use a narrow stretcher for females. Remove any muscle or chunks of fat along the skirt (bottom) of the pelt with a dull knife or one-handed scraper. Avoid getting fat or grease on the fur side of the pelt. If you do, rub the fur with sawdust to remove it.

Wild mink usually have a fat deposit under each armpit. Remove those along with the thin membrane that covers them. Be careful not to cut or rip the front legs.

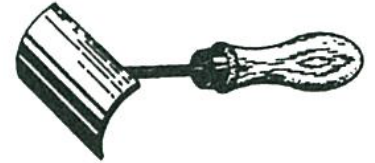

A one-handed scraper, serving spoon, or dull knife works well for fleshing muskrat and mink.



A quality fleshing knife has a sharp outer edge and a dull inner edge. The sharp edge is used to cut through and remove thick connective tissue from the back and neck. The dull edge can be used to flesh the sides and belly.

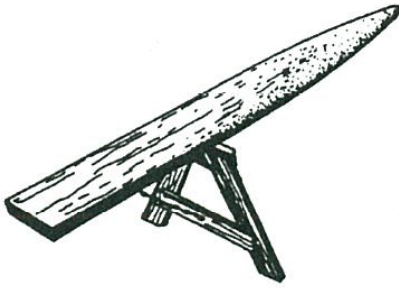

A fleshing beam provides the best surface for working on the pelts of large furbearers. The beam should match the curve of your fleshing knife; make adjustments if needed.



We recommend that you learn how to flesh pelts properly from a fur buyer or someone else with experience. This is especially true for raccoon, opossum, beaver, otter, skunk, and badger.

You will notice a thick, red membrane across the lower back (below the shoulders). This is called a “saddle.” Leave the saddle attached to the pelt unless it has a thick deposit of fat under it. This tends to be rare with wild mink or weasels.

Fox, coyote, and bobcat

Remove all burrs by combing the fur. Nicking one with your fleshing knife while working on the leather side of the pelt can cause it to tear.

Most fox, coyote, and bobcat require little fleshing. Remove any muscle tissue and chunks of fat. This is usually easier with a two-handed fleshing knife than a one-handed scraper. The cartilage at the base of the ears should be cut off with a regular knife to avoid spoilage.

Raccoon, beaver, opossum, skunk, and badger

These pelts are the most difficult to flesh. The skin is covered by a thin layer of fatty material. This layer is covered by a membrane. You must remove both for the skin to dry properly. We recommend spending time with a fur buyer or someone else with experience before trying to flesh these species yourself.

You will need a fleshing beam, plastic apron, and two-handed fleshing knife. Better brands of fleshing knives have a sharp outer edge and a dull inner edge. The sharp edge is used to slice through the membrane where it is thick, usually on the animal’s back and neck. The dull edge is used to remove thin pieces of membrane (and the fat beneath it) by applying a downward pressure, then pushing it away from you.

The belly side is the easiest place to begin. Starting at the head, use the dull edge to remove the membrane and underlying fat. Work it off as far as you can reach comfortably, then rotate the skin enough to work on the next section. Be careful around the front legs because you can cut or rip through creases or folds of loose skin.

Starting behind the ears, use the sharp side of your knife to slice through the membrane on the neck. Let the blade of your fleshing knife ride under the membrane and push it away from you.

When the part of the pelt nearest you is fleshed all the way around, hike the pelt toward you; and use your waist to pin it to the end of the fleshing beam. Continue fleshing all the way to the skirt (bottom) of the pelt. The edge of the skirt should be fleshed clean. The tail should be fleshed if it is fatty.

Fleshing beaver is similar, except that most people prefer to start behind the ears and work all the way to the tail end of the pelt using the sharp edge of their fleshing knife. After a strip as wide as the shoulders is completed, rotate the pelt; and work the fat and membrane off the sides with the dull edge of your fleshing knife. Be careful around the leg holes because it is easy to tear them.

Stretching and drying

Muskrat

Most people prefer to use wire stretchers for muskrat pelts. Place the pelt on the stretcher with the fur side in. Adjust the pelt so that the eyes and ears are centered on one side and the front leg holes are centered on the other. Poke a small hole through the pelt at a point where the center of the tail would have been attached. Insert the middle tooth of one hook and pull it downward to remove any slack from the pelt. Attach the other hook to the belly with two teeth and remove any slack.

Hang stretchers from a rafter to keep the pelts away from mice while drying. Temperatures between 40 and 60 degrees are best for drying pelts. Use a fan if the humidity is high.

Mink

Use wooden stretchers for mink. They come in two sizes. Narrow boards are used for females. Unusually small males can be put on a female board if the pelt looks too short and wide on a male board.

Place the pelt on the stretcher with the fur side in. Adjust the pelt so that the eyes and ears are centered on one side and the front leg holes are centered on the other. Grab the tail with one hand and use your other hand to stroke the pelt downward from head to tail. This removes slack without over-stretching.

Pull up and out on the tail. This helps to move part of the underside to the back of the stretcher and creates an inspection window without cutting. Lay the tail back on the board. Pull down slightly if the pelt has any slack in it.

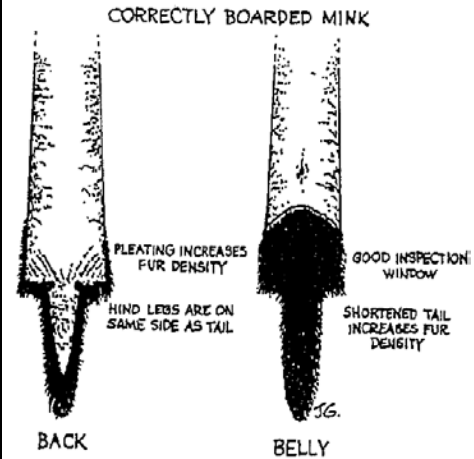

Stretching pelts according to industry standards can help you to get the best price that the market allows.

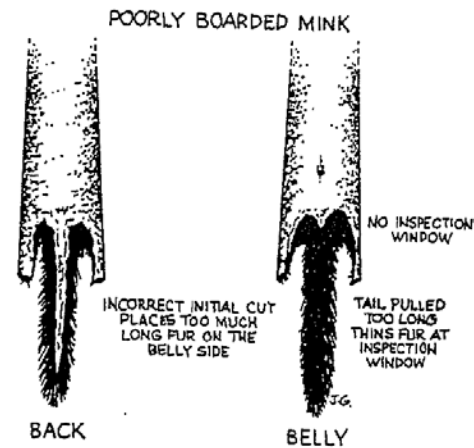

Cased pelts are measured along the back from the tip of the nose to the closet point that the leather ends at that skirt (bottom). Stretching out the legs and tail does not add to the size. This can however, reduce the fur density enough to put a pelt in a lower grade, especially if it is marginal to begin with.



Although this pelt would not be downgraded, we recommend trimming the front legs to a length of 2-3" and fastening the hook closer to the base of the tail.

CORRECTLY BOARDED RACCOON

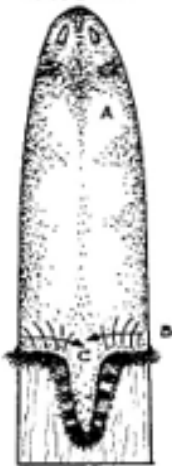

- A. SKIN IS TACKED TOWARDS CENTER
- B. TAIL IS PUSHED UPWARD
- C. MAXIMUM LENGTH PLUS MAXIMUM DENSITY IN INSPECTION AREA

Tack the base of the tail to the board using an aluminum push pin. Bunch up the pelt on both sides of the push pin until the end of the back legs come around to the same side of the board as the tail. Tack them at the edges of the board. Now tack the skin between the tail and the end of the hind legs. It should be bunched slightly between each pin to make a pleat.

Spread the tail. Beginning at the butt end, push it upward toward the skirt in small increments. You want to make it short and wide instead of long and narrow. Pin the sides of the tail or place a piece of galvanized hardware cloth over the tail and pin it to the board.

Cut off the lower lip. Trim the front legs to about $\frac{3}{4}$ " in length and poke them back between the pelt and the board. Place a "belly board" (a narrow wooden wedge) between the board and the fur side of the pelt on the belly. The pelt will shrink as it dries. If you do not use a belly board, it can shrink so tightly to the board making it difficult to remove when the time comes.

Raccoon

Use wooden or wire stretchers for raccoon. Wire stretchers are cheaper than wooden ones. They also save time because the pelt is attached by two hooks instead of tacked along the skirt. The advantage of wooden stretchers is that they give you more control over the shape of the pelt. This makes for more uniform pelts, and on average, higher prices in some markets.

When using a wire stretcher, squeeze the two sides together, and slip the pelt over the top. Release the sides and square the pelt on the stretcher so that the eyes are centered on one side and the front legs are centered on the other. Pull the pelt down snugly and fasten a hook to the tail (2-3" below the base) using one or two teeth. Use the other hook to fasten the tips of the hind legs on the belly side. Pull down on both hooks to remove any slack from the pelt. Cut off the lower lip, then trim the front legs to a length of 3".

Some people enlarge the inspection window on the belly by trimming away some of the pelt that bunches up in the groin area. This gives a neater appearance without hurting the pelt because the thin, kinky hair on the lower belly has no value.

When using a wooden stretcher, slip the pelt over the end, and adjust it so that the eyes are centered on one side and the legs on the other. Pull gently downward to remove any slack from the pelt. Tack it at the base of the tail using an aluminum push pin.

Bunch up the pelt on both sides of the push pin until the end of the back legs come to the same side of the board. Now tack the skin between the tail and the end of the hind legs. It should be bunched slightly between each pin to make a pleat.

Spread the tail. Beginning at the butt end, push it upward toward the skirt in small increments. You want to make it short and wide instead of long and narrow. Place a piece of galvanized hardware cloth over the tail to hold it in place, then pin the hardware cloth to the board.

Cut off the lower lip. Trim the front legs to about 3" in length. Place a "belly board" (a narrow wooden wedge) between the board and the fur side of the pelt on the belly. The pelt will shrink as it dries. If you do not use a belly board, it can shrink so tightly to the board making it difficult to remove when the time comes.

Fox, coyote, and bobcat

When using a wire stretcher, position and fasten the pelt with the fur side in, much like a raccoon. If the pelt is large, you might need to cross the back legs and fasten them to teeth on the opposite sides of the same hook to remove some slack. Trim off the lower lip with a knife. If necessary, trim the front legs to a length of about 4-6".

Allow the pelt to dry until the skin side is no longer tacky (4-12 hours depending on the temperature and humidity). Remove the pelt from the stretcher. Turn it inside out (with the fur facing out). If dry, the front legs can remain inside the pelt when it is turned. **NOTE: If a pelt is too dry to turn easily, place it inside a warm, damp towel for a few minutes and try again.**

Place the pelt back on the stretcher and fasten it. For coyote, we recommend placing a mink stretcher inside and turning it sideways to prop the pelt open so that air can circulate. Allow the pelt to dry completely before removing it.

The same general procedures apply to wooden stretchers. You can purchase solid wooden stretchers or adjustable wooden frames. Remember to use a belly board for solid wooden stretchers. Do not cut an inspection window in fox, coyote, or bobcat.

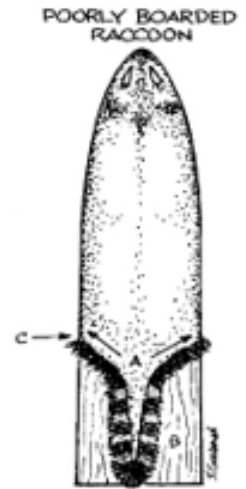

- A. SKIN IS PULLED AWAY FROM INSPECTION AREA, WEAKENING THE FUR
- B. TAIL IS PULLED TOO TIGHT, TAKING FUR DENSITY FROM INSPECTION AREA
- C. LENGTH IS LOST FROM NOT BRINGING THE EDGES DOWN TO THE BASE OF THE TAIL

NOTE:

Never try to make a pelt bigger than it is by "stretching" it. Pelts should be pulled tight enough to take the slack out of them – no more, no less.

Beaver

Beaver pelts are stretched open on a piece of plywood. The correct shape is oval. Ask a fur buyer or auction house for a pattern that can be traced directly onto your stretching boards.

Spread the pelt on the board, fur side down. Choose a pattern that best fits its size. As a rule of thumb, you will lose 3-4" in length when you tack the sides. Tack the nose, butt, and middle of both sides with 4d (4-penny finishing) nails. Next, tack the pelt between each of these nails. If the pelt seems too tight, pull the nails and begin again on the next smallest pattern.

Tack the pelt every $\frac{1}{2}$ - $\frac{3}{4}$ ". Trim any fat or gristle from the edges of the leg holes and nail them closed. Trim the lower lips to give a nice even curve to the top of the pelt. Using a screwdriver, lift the edges of the pelt away from the board so that the pelt dries evenly.

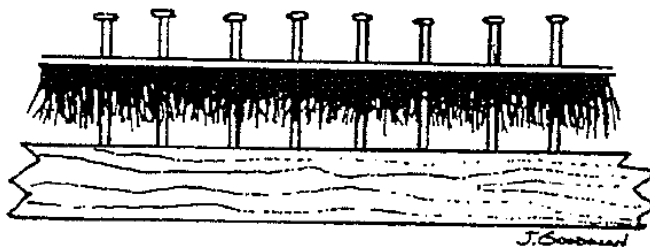
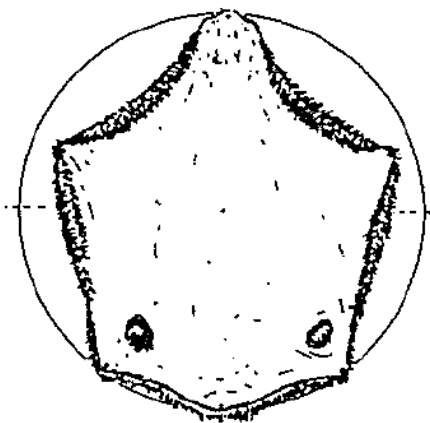
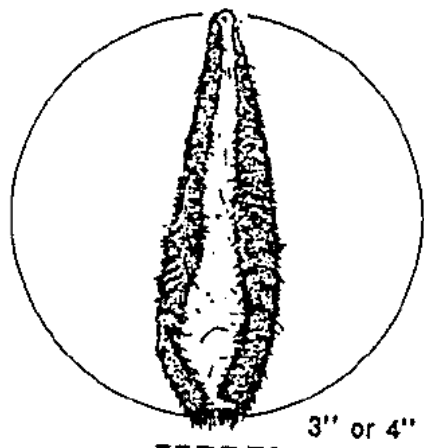

Experienced beaver trappers sometimes skin a beaver partly open, and partly closed. This allows for a better hold on a fleshing beam. When fleshing is complete, they finish cutting the belly so they can board the pelt.

TRIM OFF LOWER LIPS

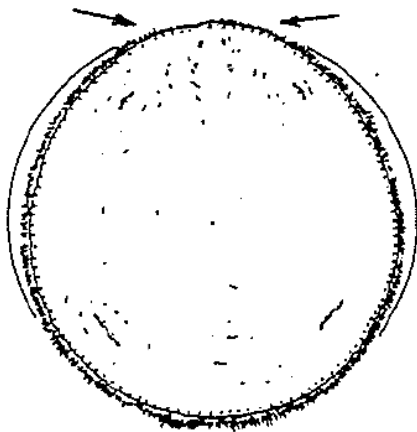

Summary of fur handling techniques

Species	Skinning method	Tail	Fur side	Stretcher size (wire)	Fleshing & stretching
Muskrat	cased	off	in	#1	do not over-flesh
Mink (male)	cased	on	in	not recommended	see boarding instructions
Mink (female)	cased	on	in	not recommended	see boarding instructions
Opossum	cased	off	in	#2 or #3	flesh carefully to avoid tears
Raccoon	cased	on	in	#4 or #5	flesh through membrane
Skunk	cased	on	in	#2 or #3	flesh through membrane
Weasel	cased	on	in	not recommended	little/no fleshing required
Fox	cased	on	out	#4 or #5	turn pelt fur side out when skin is dry to touch
Coyote	cased	on	out	#6	turn pelt fur side out when skin is dry to touch
Bobcat	cased	on	out	not recommended	little to no fleshing; turn pelt fur side out when skin is dry to touch; boarded on same boards as coyotes
Beaver	open	off	NA	adjustable hoops	boards are better than hoops; correct shape is oval
River Otter	cased	on	out	not recommended	best done on a beam with Good, sharp two-handled knife; remove fat under saddle; dry fur side in

Standard sizes for stretching boards (all measurements in inches)

Species	Length	Width at base	Width from nose to base
Mink (male)	36	4-5	1 ¼ @ 1 ½; 2 @ 2 ¾; 2 ½ @ 7; 3 @ 15; 4 @ 30
Mink (female)	30	3-4	1 ¼ @ 1; 1 ¾ @ 3; 2 @ 6; 2 ¼ @ 14; 2 ¾ @ 27
Raccoon (XL+)	48-54	9	6 ½ @ 11; 8 ½ @ 30
Raccoon (XL-)	48-54	8	5 @ 5 ½; 7-7 ½ @ 25
Fox (XL+)	66	7	2 ½ @ 2 ¾; 3 @ 3 ½; 4 @ 6; 5 @ 9; 6 @ 14; 6 ½ @ 18; 7 @ 35
Fox (XL-)	66	6 ½	2 @ 1 ¾; 3 @ 3 ½; 4 @ 6; 5 @ 10; 6 @ 17; 6 ½ @ 24
Coyote (XL+)	72	9	4 @ 3; 5 ½ @ 5; 6 @ 7 ½; 6 ¾ @ 12; 7 ¼ @ 17; 9 @ 39
Coyote (XL-)	72	7 ½	3 ½ @ 3; 4 ½ @ 5; 5 ½ @ 7 ½; 6 ¼ @ 12; 6 ⅝ @ 17; 7 ½ @ 39
Bobcat (XL)	72	9	4 @ 3; 5 ⅝ @ 5; 6 @ 7 ½; 6 ¾ @ 12; 7 ¼ @ 17; 9 @ 39
Weasel (XL+)	18-20	2 ½	1 @ 1; 1 ⅜ @ 1 ¾; 1 ⅝ @ 3 ½; 2 ½ @ 16
Weasel (XL-)	16-18	2	1 @ 1; 1 ¼ @ 1 ¾; 1 ⅜ @ 2 ½; 1 ½ @ 4
River Otter (XL+)	72	8	4 ¾ @ 6; 6 @ 12; 7 ½ @ 24; 8 @ 38
River Otter (XL-)	72	7	4 ¾ @ 6; 5 ½ @ 12; 6 ¾ @ 24; 7 @ 32

XL+ = pelts graded as extra-large or larger

MARKETING YOUR FUR

Furs are a worldwide commodity. Their value at any given time is determined by supply (the number of pelts for sale) and demand (the number of pelts needed for manufacturing garments and other products). Much of the demand for furs comes from markets in Europe, Russia, and Asia. Therefore, the economic health and buying power of these regions affect their demand and the price you receive for your pelts.

Manufacturers usually hire a broker to fill orders for pelts. When possible, buyers deal directly with brokers to resell your pelts. Buyers who do not have contracts with brokers resell your pelts to other buyers. This might take place several times before your pelts make their way to a broker.

Buyers' profits come from selling your pelts for more than they paid after accounting for their time and expenses. They usually operate on a narrow margin, and a sudden shift in supply or demand can increase their profit or turn it into a loss.

While it is rare to meet a trapper without a story about being "taken" by a fur buyer, it is even rarer to find a fur buyer who stayed in business by cheating customers. Established fur buyers pay fair market prices to keep your business. This price can vary from buyer to buyer, but it is usually in the same ballpark. To get the best possible price for you furs:

- Monitor market conditions by following reports in trapper magazines.
- Shop around if you have doubts about an offer – you are not committed to taking it.
- Take pride in the way you handle your furs – clean, fresh furs without damage are worth more in any market.

At auctions, the sponsors charge customers a commission, usually a percentage of your proceeds. This fee pays for the sponsors' expenses and includes their profits. Most state sponsored auctions allow you to set a minimum bid price for your furs. International auctions do not allow you to set a minimum bid, but the sponsors can withdraw a lot if the price does not meet their expectations. After all, their profits are tied directly to yours.

"Fur in" or "Fur out"

Fur markets want pelts presented either "fur in" or "fur out," depending on the species of the pelt.

Fur IN

*River Otter
Skunks
Weasels
Raccoon
Mink
Muskrat*

Fur OUT

*Gray fox
Red fox
Coyote
Bobcat*

OPEN Fur

Beaver

Local buyers

Local buyers purchase whole unskinned animals, skinned, unfleshed pelts, and those that have been fleshed. They are usually convenient and great source of information about trapping and fur handling methods.

Some local buyers advertise in area newspapers, but many rely on “word of mouth” for new customers. Asking experienced trappers or fur hunters is a good way to locate buyers in your area.

Traveling fur buyers

Some of the larger companies set up “truck routes.” Their buyers travel from town to town, making stops at designated places and times. Most routes are run weekly or every other week. You can find out if a stop is scheduled in your area by checking the local newspaper two weeks before the season opens.

Traveling buyers purchase whole unskinned animals, skinned, unfleshed pelts, and those that have been fleshed, stretched and dried. Unless you schedule your trapping activities so that your catch is fresh when a buyer stops in town, you will need to freeze your furs or flesh, stretch, and dry them so that they do not spoil.

Auctions

Auctions are an option only if your furs are fleshed, stretched, and dried. Some state trapping organizations sponsor auctions as a service to their members. These auctions are advertised in newsletters or magazines that come with your membership.

All of the international auction houses advertise in trapping magazines. Contact a company’s office or one of its representatives to set up an account. They will assign an account number and send shipping tags, auction schedules, and instructions. When your furs are fleshed, stretched, and dried, you can ship them to a receiving station. In some cases, you can deliver them to a representative who collects furs along a truck route before each auction. Payment for furs sold at auction is made within 30 days after it ends. All unsold pelts are stored for future auctions. If requested, the company will return unsold pelts for the cost of shipping and handling.

FUR GRADING TERMS

The value of a pelt is determined by its size, fur density, damage, color, and clarity. Standards for these criteria differ among species and regions.

To determine the size of cased skins that are stretched to meet industry standards, measure the pelt along the back from the tip of the nose to the nearest point that the leather ends at the skirt (bottom of the back).

Grades

Grades reflect the degree of primeness and, to a lesser extent, damage (in many cases, damage is evaluated separately). The best pelts are graded as select; the worst as fourths. Categories are sometimes combined to make a new grade. For example, the poorer firsts and better seconds might be grouped to form a grade of "I and II."

To qualify as a select or first, both the underfur and guard hairs must be dense and at maximum length. No weakness (lack of density) occurs on the neck or flanks. The guard hairs are soft, silky and have a good "flow" (they are supported by dense underfur and snap back into place when rubbed from tail to head). The leather is soft, pliable and creamy white.

Select – fully prime; no damage or blemishes.

Firsts (I) – fully prime; slight damage (up to 5%) is allowed in this grade.

Seconds (II) – not quite prime or somewhat past prime; if the grade includes damage, firsts with up to 10% damage are allowed.

Thirds (III) – unprimed (dark blue leather) or past prime; if the grade includes damage, firsts and seconds with more than 10% damage are allowed.

Fourths (IV) – totally unprimed or past prime; includes pelts that are badly damaged.

Damages

Damage affects the price of a pelt because it reduces the amount of fur that's useable. It also represents a risk to the manufacturer. For example, an old scar that rips during the tanning process can ruin a larger part of the pelt.

Standard sizes and lengths (in inches)

Raccoon

4XL	more than 35
3XL	32-35
2XL	29-32
XL	27-29
LGE	24-27
LM	22-24
MED	20-22
SML	less than 20

Wild mink

XL-L	more than 21
L-M	18-21
MED	17-18
SML	less than 17

Muskrat

2XL	more than 16 ½
XL	15-16 ½
LGE	13 ½ -1 5
L-M	12-13 ½
MED	10 ½ -1 2
SML	9-10 ½
X-SML	less than 9

Coyote

XL-L	more than 36
M-SML	less than 36

Red fox

XL-L	more than 28
M-SML	less than 28

Opossum

3XL/ 2XL	more than 22
XL/ LGE	18-22
M-SML	less than 18

Bobcat

3XL	over 44
2XL	40-44
XL	36-40
LGE	32-26
MED	28-32
SML	under 28

**Standard sizes and lengths
(in inches)**

River Otter

3XL	over 42
2XL	40-42
XL	38-40
LGE	34-38
MED	32-34
SML	30-32
X-SML	under 30

Beaver

2XL (blanket)	more than 65
XL	60-65
LGE	55-60
L-M	51-55
MED	47-51
SML	42-47
X-SML	less than 42

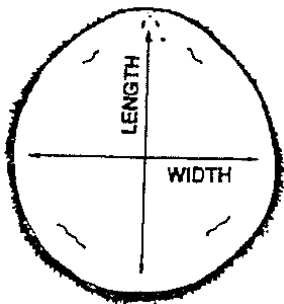

Add length and width of a pelt to get the size for beaver.

Damage comes in many forms. Some can be prevented, some cannot. Types of damage include scars from fighting, tick bites, open or partially healed wounds, bullet holes, knife cuts, taints, and rubs. Some of the categories include:

Slight (SL, SLI) – top quality pelts with minimal damage. An otherwise perfect pelt with a small hole that is sewn properly is a good example.

Slight Damaged (SL DGD) – good quality pelts (select, I, and II) with more damage than a slight. Damage must be confined to an area that does not affect the most desirable part of the pelt.

Damaged (DGD) – pelts graded as I and II or the better seconds that are torn or cut badly, or have large sews, taints or rubs.

Color

Sorting by color allows manufacturers to obtain groups of pelts with a similar appearance. Some pay a premium for colors that are in fashion or best suited for a particular use. Colors typical of a species are called “ordinary.” Those that are darker or lighter than normal are put in groups that range from extra dark to extra pale.

Crispness and uniformity of color are also considered in the grading process. For example, a raccoon with bright silver and black guard hair is called “clear” (A), one with yellowish or reddish tinge is graded as “slight off” (B), “off” (C), or “bad off” (D), depending on the degree.

Glossary of fur grading terms

Bitten – pelt has holes caused by bites. This is most common in muskrat and beaver captured during late winter or early spring when they are breeding and establishing new territories.

Burnt – pelt is brittle and sometimes cracked, usually from drying it too fast near a heater or in the sun and wind. It is also caused by leaving too much grease on the pelt.

Clipped – patches of guard hair have been chewed off by rodents.

Cotton mink – underfur is off-white in color.

Course – guard hairs are dull, lifeless, and hard to the touch. This is usually seen in late-caught furs.

Flat – guard hairs lay flat because the underfur is not fully developed. This is usually seen in early-caught furs.

Loose – guard hairs are coming out, usually because the roots have been cut by over-fleshing. This is sometimes seen in early-caught furs.

Rubbed – a patch of guard hair was worn off where an animal brushed against something repeatedly as it entered and exited a den.

Scored – mark left by a bullet or knife that cut partway through the leather.

Shedder – fur “sheds” easily from the pelt when raked with the fingers. This is usually caused by putting a pelt on a stretcher while the fur is still wet.

Singed – guard hair is bent or hook-shaped. This is most common in mink and river otter when the fur is exposed to bright sunlight and dries out. This is sometimes caused by excessive handling or drying the fur near a heater.

Springy – underfur is falling out or kinked and woolly in appearance. This is usually seen in late-caught furs.

Tainted – part of the pelt has spoiled. This is usually caused by waiting too long before skinning an animal or failing to remove enough of the tissue and fat during the fleshing process.

USE AND DISPOSAL OF CARCASSES

Selling your catch “in the round” is one way to dispose of carcasses. It also ensures that the whole animal is used. Fur buyers hire rendering companies to haul away skinned carcasses and scraps. These “leftovers” are processed into ingredients for pet food, lubricants, soap, paint, tires, and other products.

If you skin animals yourself, you will need to dispose of the carcasses properly. We recommend that you use or sell as much as possible and bury the rest under at least 6” of compacted soil in an area where runoff will not contaminate water supplies. “Recycling” carcasses by burying them is no different than if the animals had died of natural causes.

Meat

The meat from beaver, muskrat, and raccoon is edible. Markets exist in some parts of the state, especially for raccoon. You will need to purchase a Wild Game Food Dealer's Permit from the IDNR if you sell meat directly to consumers. You do not need a permit to sell meat to a middle man (like a fur buyer who has a Wild Game Food Dealer's Permit) or if you donate meat to an organization that is sponsoring a wild game dinner.

Fresh muskrat carcasses make excellent bait for mink, raccoon, and other predators. Beaver can be used to feed dogs or attract fox and coyote to your sets.

Glands

Glands of some species such as beaver, skunk, and coyote can be sold to lure manufacturers or used in your own formulations. Castoreum, a substance produced by beaver, is almost always in demand. It is used as an ingredient in some perfumes and cosmetics. The glands that contain castoreum are grayish, wrinkled, and found under the skin just above and on both sides of the vent. They should not be confused with the oil sacs, which are off-white and smooth.

To remove the glands, make a cut through the dark red membrane that surrounds them. Avoid cutting, tearing, or separating the glands (also called castors) while removing them. Using your fingers, peel the glands free from the surrounding fat and tissue. When finished, use a knife to separate them from the carcass (the two "pods" should stay attached by a ribbon of tissue at the center).

Allow the glands to dry by hanging them over a wire or placing them on a piece of wire mesh in a cool, well-ventilated area. Check them in a couple of days and turn or spread the glands to expose any parts that are not drying properly. Once dried, the castors can be packed loosely in an airtight plastic container and frozen. Take them out of the freezer and spread or hang them to dry for a couple of days before selling or shipping. Never use plastic bags to store or ship castors. Instead, use a mesh bag (like those that onions and oranges are sold in) enclosed in a cardboard box.



Skulls, teeth, bone, and claws

Some companies specialize in animal parts that are used for arts, crafts, and novelties. Check trapping magazines for advertisements and contact the companies for prices and instructions on handling.

HOME TANNING

Home tanning takes practice to get the right results. We recommend using a couple of low-quality pelts on your first attempts.

Flesh pelts, making sure they are as clean as possible (free of fat, tissue and membrane). Rub liberal amounts of salt into the flesh side of the pelts. Roll them up, flesh side in. After 2-3 days, unroll the pelts and remove all remaining fat and flesh (the salt helps to loosen it). Pay close attention to areas near the eyes, ears, and lips.

Wearing rubber gloves, de-grease the pelts (both skin and fur sides) by rubbing them with naphtha thinner (available at hardware stores). Use this product outdoors and away from flames as it is highly flammable. After working naphtha into the skin, rub the pelts liberally with sawdust to remove dissolved grease, salt, and chemicals. Repeat this step 3-4 times, shaking the sawdust out of the pelt after each application. When finished, rinse the pelt in fresh water at least 7-8 times.

Place the pelts in a solution of ½ lb. salt and ¼ lb. alum per gallon of water, making enough to cover them completely. Pelts with thin skins (like rabbit, muskrat or fox) will take 2-5 days to cure; those with thick skins (like large beaver) can take up to two weeks. Stir daily.

When the pelts have finished soaking, remove them from the solution and rinse thoroughly in clear water. Hang them up for an hour or so to let most of the water drain. Do not let them dry out.

Lay the pelts skin-side up and apply a solution of one-part Neatsfoot oil to two-parts hot water. Work the oil into the hide with a wire brush, then fold the skin, flesh side to flesh side, and leave overnight. The next day, wipe off excess oil with a soapy rag, and hang the pelts to dry.

Watch the pelts closely and work them when they show signs of drying. This is done by pulling the flesh side back and forth over a beam or a dull axe

“Firsts” in furbearer management in Illinois:

- 1907** *First protective harvest regulations.*
- 1919** *Trapping license required by law.*
- 1925** *Fur buyer’s license required by law.*
- 1933** *Closed trapping season for beaver.*
- 1936** *First wildlife restoration project – beaver released in southern Illinois.*
- 1939** *First restrictions on trap sizes.*
First research project: status, distribution, and harvest of Illinois furbearers.
- 1951** *Beaver populations recovered enough to open a limited season.*
- 1953** *Trappers required to mark their traps with their name and address.*
- 1975** *First time a “road kill index” was used to track trends in numbers of raccoon and skunk.*
- 1976** *State hired a full-time furbearer biologist. First time that harvest levels tracked consistently and accurately.*
- 1978** *First time mail surveys were sent to trappers to track their catch, effort, and opinions.*
- 1980** *Trappers required to check their sets every day. Traps with teeth were outlawed.*
Den sets prohibited on land to prevent non-target catches.

1980 Exposed bait prohibited on land to prevent non-target catches.

Trends in opossum numbers tracked for the first time using a "road-kill index."

Deer hunters surveyed at check stations to track changes in coyote numbers.

1981 Trends in raccoon numbers tracked for the first time using a "spring spotlight survey."

Trapper Education Coordinator hired by the IDNR.

First trapper education class.

1985 Attending a Trapper Education course became mandatory for first-time trappers under 18 years of age.

1986 The IDNR joins the Fur Institute of Canada to support efforts to improve animal welfare.

1989 New law requires a Furbearer Stamp for hunting and trapping; sales support furbearer research, education, and conservation.

The IDNR tests traps for efficiency, animal welfare.

1991 Numbers of red fox and other furbearers tracked with "archer index."

1994 First attempt to recover an endangered species - river otters released in Illinois.

1999 Status of river otter and bobcat upgraded by the Endangered Species Protection Board.

"Sign survey" used for the first time to monitor river otter, mink, and beaver.

blade held by a vise. The more the hide is worked and stretched while drying, the softer it will be. Take care with thin hides to avoid tearing them. When the pelts are fully dried, you can sand the flesh side lightly with sandpaper to get a smooth finish.

WILDLIFE MANAGEMENT

Trained wildlife professionals support regulated trapping because it provides many benefits to society without endangering wildlife populations or damaging the environment. The IDNR agrees with this philosophy. Some of the responsibilities that come with this commitment include:

- Monitoring wildlife populations.
- Maintaining and improving wildlife habitats.
- Monitoring harvest levels.
- Conducting research on wildlife ecology and management.
- Recommending and enforcing laws that keep wildlife from becoming endangered.
- Recommending and enforcing laws that improve animal welfare.
- Licensing and educating trappers.
- Providing opportunities to trap on public lands.

Wildlife means different things to different people. Some like to watch animals for enjoyment, some want opportunities to harvest them, and others consider them a nuisance. Managers try to balance these interests, along with the top priority of keeping the animals from becoming endangered.

In the end, wildlife management comes down to three simple choices: increase, maintain, or reduce a population. Steps taken to increase a population can include things like improving habitat conditions, restricting or prohibiting harvest, and capturing animals where they are abundant, then releasing them where they are not.

Maintaining a stable population is the most common goal and usually allows for a limited harvest. Some populations get so high that they cause problems for people or other wildlife. In these cases, regulations are relaxed to help encourage higher harvest levels.

Monitoring wildlife populations is a key part of this process. Counting every animal is impossible. Instead, biologists rely on partial counts or, more

commonly, indirect evidence that shows whether a population is up, down, or stable from one year to the next. Methods vary widely from one species to the next.

Monitoring harvest levels is relatively simple. By law, fur buyers are required to keep records and provide a summary of their purchases for the year. Harvest levels are also estimated from reports submitted by a random sample of trappers who receive a mail survey.

BEST MANAGEMENT PRACTICES

Most people, including trappers, care about the animals and their welfare. The IDNR agrees with these concerns and the need to address them through appropriate laws and education programs. Outlawing traps with teeth, limiting trap sizes, requiring daily trap checks and providing Trapper Education courses are examples.

Efforts to improve animal welfare, while maintaining the efficiency and practicality of trapping, have been around for a long time. The most recent and comprehensive effort involves development of “Best Management Practices” (BMPs) for trapping.

This project started in 1996 and was scheduled for completion in 2003. During the first phase, dozens of traps were tested for efficiency, selectivity, and injuries to animals. Traps that stand out in all three categories were identified by a team of biologists. Their findings were used to develop BMPs for different species and parts of the country by 2002.

The Association of Fish and Wildlife Agencies’ Furbearer Resources Task Force has been responsible for the project. Professional furbearer biologists from all regions of the country have been involved in the project. Additionally, the U.S. Fish & Wildlife Service Division of Federal Aid and the U.S Department of Agriculture’s Animal Damage Control program assisted. The National Trappers Association supported the project and was actively involved in all stages.

BMPs are continually updated and revised as needed. BMPs are published and made available to trapper organizations, state wildlife agencies, and any other interested party.

Website: <http://www.fishwildlife.org> (search furbearer management)

What are BMPs?

- *BMPs are based on regional differences in trapping conditions (e.g., climate, species trapped, and habitat).*
- *BMPs are developed for specific trapping conditions (e.g., land vs. water) in a region.*
- *BMPs recognize the fact that a given trap may be used to catch several target species.*
- *BMPs include descriptions of the best traps, as well as recommendations for setting traps.*
- *The evaluations included efficiency, selectivity, user safety, practicability, and injuries.*



All 50 states’ fish and wildlife agencies support the continued development of BMPs.

Why are BMPs needed?

- *To ensure the continued responsible management of wildlife resources.*
- *The process of improving traps and trapping methods need to continue to maintain and improve animal welfare.*
- *Real and perceived problems associated with trapping need to be reduced to maintain public acceptance.*
- *This is necessary to sustain regulated trapping now and, in the future, and to maintain the integrity of furbearer management programs throughout the United States.*

BRIEF HISTORY OF TRAPPING

Trapping played a key role in the early exploration and settlement of North America. Trappers pushed deep into uncharted territories as they searched for beaver, which were prized for making felt hats for European markets. Their travels led to the discovery of many rivers, lakes, and mountain ranges, blazing the way for pioneer farmers and ranchers. Some of the most famous hunter-trappers include Daniel Boone, Jim Bridger, and Kit Carson.

The fur trade fueled growth in North America from 1608 when Champlain established the first trading post at Quebec, to the 1830s, when silk replaced beaver fur as the most popular material for making hats. Cities like New York, Chicago, and St. Louis owe their early success to trading posts at these locations. Many of America's most prominent citizens made their fortunes in the fur trade. John Jacob Astor, owned the largest commercial enterprise in the United States during the early 19th century.

Many of Illinois' modern cities began as fur trading posts. Kaskaskia (near present day Chester), and Cahokia (now part of the St. Louis metro area) were important posts in the late 1700s when large collections of furs from Illinois were shipped down the Mississippi Valley region in the 19th century. In 1816, traders shipped 10,000 deer, 300 bears, 10,000 raccoons, and 400 river otters from the Illinois River Valley alone.

Other cities with roots to the trade include Peoria, LaSalle, Kankakee, Danville, and Cairo. St. Louis dominated the fur trade in the Midwest from the end of the Civil War until the 1950s. The importance of regional trade centers eventually faded with advances in transportation and communication systems that allowed the direct export of furs from Illinois to world marketing centers like New York, Montreal, Winnipeg, and London.

Trapping is no longer a centerpiece of Illinois' culture or economy. However, it remains an important tradition and lifestyle for many people, especially in rural parts of the state.

BEING AN ADVOCATE

If you asked 100 strangers whether trapping is an acceptable practice, most would say no. It is not because they dislike you. It is not because they oppose the use of animal products. Nearly all of them eat meat, drink milk, or wear leather products.

So why are they so quick to respond with a no? More often than not, it is because they know very little about trapping, and their response is based on the belief that killing animals is wrong unless it somehow benefits society and is done responsibly. You will not change this philosophy. In fact, you probably agree with it as strongly as anyone.

What you can change is peoples' awareness of the benefits, oversight, and responsibilities that come with trapping. People are less likely to oppose trapping if they recognize that it is highly regulated, does not endanger animals, and benefits society.

Why should you care? The future of trapping depends on it. Help to maintain regulated trapping by taking every opportunity to let people know:

Trapping does NOT cause wildlife to become endangered.

- All animals that are trapped in Illinois are abundant.
- In North America, every endangered species is protected by laws that prohibit hunting and trapping.
- Trapping removes part of a surplus that is produced each year, it does not harm the population's future.

Trapping is highly regulated.

- Laws that require daily trap checks, limit trap sizes, and prohibit certain types of traps help to ensure that trapping is as humane as possible given current technology (for example, it is illegal to use traps with teeth on the jaws).
- Regulations are enforced by specially trained Conservation Police Officers – fines and jail terms are set by the courts.
- Animals can only be trapped during fall and winter – this protects babies, or mothers with newborns.
- Regulated trapping is endorsed by trained wildlife professionals who care about the overall welfare of wildlife.

Tips for being an effective advocate:

Begin by memorizing the main messages (those in bold). Practice them. Use them whenever the opportunity arises. Fill in the supporting messages as you gain experience.

Assume a fog, not a brick wall, when it comes to peoples' attitudes about trapping. Most will listen if you are sincere and stick to the facts. You are not trying to make them a trapper. You are hoping they will recognize that trapping is necessary and an appropriate activity that should be allowed to continue.

Join local, state, and national trapping organizations to stay informed on improvements and threats to trapping. Write legislators when the need arises.

Above all, be polite, truthful, persistent, and respectful.

Trapping provides many benefits to society.

- Trapping can help wildlife from becoming overpopulated, especially in areas where humans have removed natural predators or altered the natural habitat.
- In many situations, trapping is necessary to reduce or prevent damage to crops and other property.
- Parts of animals that are not used for fur coats are often processed into soap, paint, pet foods, and other items that include animal by-products.
- License fees and excise taxes on certain kinds of sporting equipment are used to manage all of Illinois' wildlife, not just those that are hunted or trapped.
- In some situations, trapping can help to keep animals from becoming so abundant that they harm their own environment.
- Trapping can help reduce the potential for wildlife diseases, such as rabies.
- Trapping can be an important tool for saving endangered species when their populations are being ravaged by predators or their status can be improved by capturing animals in areas where they are common and releasing them where they are rare or absent.

THE NORTH AMERICAN MODEL OF WILDLIFE CONSERVATION

The United States and Canada have the most successful system of wildlife management the world has ever known. Conservationists, especially hunters and trappers, supported the development of The North American Model of Wildlife Conservation. This model is defined by seven principles:

1. Wildlife as a Public Trust

Legally, wildlife is a public resource, held in trust by the government, and managed by fish and wildlife agencies. State wildlife agencies are responsible for the most wildlife management and regulation. The U.S. Fish and Wildlife Service has authority over migratory birds and federally endangered species. The Service works cooperatively with the states and other nations.

2. Elimination of Markets for Wildlife

The elimination of market hunting of most wildlife for meats, feathers, or other uses was critical in halting what would have been a “tragedy of the commons.” Using regulated trapping, furbearer populations will sustain a commercial market and provide significant benefits to society.

3. Allocation of Wildlife by Law

Public privileges to use wildlife and have a say in its management are guaranteed by law. Hunting and trapping privileges are not restricted to wealthy landowners or granted as special considerations. Individuals can lose their privileges if they violate laws pertaining to the legal harvest of wildlife.

4. Wildlife May Be Killed Only for a Legitimate Purpose

Killing wildlife for frivolous reasons is prohibited by law. If society is going to sanction the killing of wildlife it must be for a legitimate purpose such as using the animal or its parts for food, clothing, medicine, self-defense, or property protection.

5. Wildlife Is Considered an International Resource

The Migratory Bird Treaty of 1916 between the United States and Canada was the world’s first significant international treaty for the management of wildlife. Today, waterfowl, songbirds, and other migratory wildlife benefit from international management and regulation.

6. Science is the Proper Tool for Discharge of Wildlife Policy

Science has been the primary basis for wildlife restoration and management, and the formation of the wildlife profession. North Americans used wildlife science as a basis for managing wildlife decades ahead of everyone else in the world.

7. Democracy of Hunting and Trapping

In North America, everyone has the opportunity to participate in regulated hunting and trapping. President Theodore Roosevelt wrote about the societal gains to be made by keeping land available for hunting for all people. This is very different from a model that existed for centuries in Europe, where wealthy people owned wildlife and the land, and only the wealthy could fish and hunt. In North America, wildlife is owned by the public, and responsible citizens have equal opportunities to participate in regulated hunting or trapping.

Hunters and trappers provide the funding for wildlife management programs and purchase of critical habitats. When they join together with a

**IDNR Policy and
Procedure Manual
Chapter 5, Section 5G-1
July 1, 1997**

The IDNR supports regulated trapping and efforts to address societal concerns through appropriate education, research, enforcement, and regulatory programs. Such programs shall be designed to increase awareness and acceptance of trapping by seeking to enhance animal welfare while maintaining management capabilities and other benefits associated with this activity.

common purpose, hunters and trappers are a political force speaking out in favor of wildlife conservation.

Thanks to conservation-minded hunters and trappers, species such as elk, deer, geese, wild turkeys, wood ducks, beaver, bald eagles, and river otter are more numerous today than they were in 1900. Hunters, trappers, and other conservationists were the first people to place a value on living wildlife. As a result, wildlife is now managed as a public resource to be conserved for the benefit of all.

IDNR POLICY ON TRAPPING

The IDNR recognizes that regulated trapping is a versatile, safe, effective, and ecologically sound means of capturing individual animals without impairing the survival of furbearer populations or damaging the environment. Trapping provides income, recreation, and an outdoor lifestyle for many citizens through use of a renewable natural resource. It also provides an effective means of harvesting, managing, and/or studying furbearers, controlling damage caused by furbearers, and, at times, reduces the spread of harmful disease. The IDNR also recognizes that trapping is a concern of some segments of the public who oppose trapping or the use of specific trapping devices.

Fur Takers of America

Fur Takers of America (FTA) was formed in 1968 with the publication of its first magazine being in the spring of that year. The first officers of the organization were Wally Schmieg, Paul LeGer, Claude Cochrane Jr., John Parker, & Eddie Stephenson. The first convention was held on Labor Day weekend of 1968 in Smithboro, IL at the Ed Bauer Fur Company. The purpose of the Fur Takers of America is best stated in this excerpt from the first constitution, "We, the Fur Takers of America, do hereby pledge to further the heritage bestowed on us by the fur takers who have gone on before us. We pledge to conserve and maintain an adequate supply of furbearing animals, establish a better fur trade, support other organizations benefitting the fur taker, and helping our brother fur takers in their fight for fair laws throughout America." On October 28, 1969, Fur Takers of America was incorporated in the state of Missouri with Wally Schmieg, John Parker, and Keith Rider being named as the first Board of Directors. FTA continues to be incorporated in the state of Missouri as a not-for-profit organization, run almost exclusively by volunteers. The original incorporation papers stated the following as one of its purposes: "To promote interest in and accumulate and disseminate knowledge concerning the trapping of fur bearing animals among persons interested therein on an amateur basis." Education of both young and old has been and will always be, one of the major goals of FTA. FTA's purpose could be summarized as "Preserving our heritage while protecting our future."

SPECIES PROFILES

Badger



Badger

USFWS Photo



Front:

Length - 2½"

Width - 2"



Hind:

Length - 2"

Width - 2"



Track pattern

Distribution: Found throughout the State, but more common in the northern half.

Habitat: Prefers large grassland areas, but few remain in the State. They make the most of scattered grassy areas like pastures, roadsides, fencerows, field borders, ditch banks, and railroad rights-of-way. Badgers can also be found near woodlots, old cemeteries, and idle crop fields.

Habits: Generally, live alone except when raising their young. In excellent habitat, most of their movements occur in an area 1-2 miles in diameter. Where grasslands are scattered, they roam much larger areas – up to five square miles for females and 15 square miles for males. Badgers are most active at night but they might also be seen shortly after dawn or just before dusk.

Adaptations for burrowing include a low profile, powerful front legs, partial webbing between the toes of the front feet, long claws (up to 2"), and clear membranes that protect their eyes from falling dirt. These traits help them to dig out and kill burrowing rodents, which are a main part of their diet.

Foods: Common prey include mice, ground squirrels, woodchucks, and voles. Other foods include snakes, toads, cottontail rabbits, moles, beetles, grasshoppers, mulberries, carrion (dead animals), and ground-nesting birds and their eggs.

Reproduction: Badgers have one litter per year. Consisting of an average of three young are born between late March and early June.

Conservation: Badgers are common enough to allow a limited trapping season. This gives trappers a chance to remove animals that are causing damage by burrowing in crop fields, airports, old cemeteries, and other unwanted places. It also allows use of a natural, renewable resource without endangering the health of the overall population.

Establishing and maintaining grassland habitats are the most important conservation measures for this species.

Beaver

Distribution: Common throughout the State.

Habitat: Streams, rivers, marshes, lakes, and ponds.

Habits: Beaver are well known for building dams across streams and small rivers. This increases the depth and surface area of water behind the dam, allowing the beaver to have easier access to food along the shoreline and better protection from their enemies. More importantly, it allows success to underwater den entrances and food caches in winter, even when thick ice forms overhead.

Lodges are found mostly in swamps or marshes. They are dome-shaped structures built of sticks, mud, and debris. Burrows with underwater entrances angle upward to a nest chamber above the water line. Beaver dig “bank dens” directly into steep-sided shorelines of streams, rivers, and lakes. They usually have two or more underwater entrances. In Illinois, bank dens are more common than lodges.

Groups of beaver that live together are called colonies. Most colonies start with a pair of adults. They are joined by their young the following spring and the year after that. During the third year, the adults drive off the oldest litter to make room for their newborns. Colonies that have existed for three years or more can have as many as 8-12 beaver. However, the average is about half this number.

Foods: Tender twigs and the inner bark of trees like maple, willow, cottonwood, and birch are a staple during winter. Their diet shifts to roots of aquatic plants, marsh grasses, clover, and berries during summer. Corn is a favorite food in autumn.

Reproduction: A single annual litter is born during April, May, or June. The average litter size is 3-4 kits, but some females have as many as 6-7.

Diseases: Tularemia is a bacterial disease. You can get it from beaver by coming in contact with contaminated blood, tissue, or water. Human symptoms include headaches, chills, vomiting, fever, aches, and pains. Giardiasis, a parasitic disease, causes acute diarrhea and abdominal pains in humans. Drinking contaminated water is the most common means of transmission.

Conservation: Beaver are an important part of the ecosystem because their dams create fish and wildlife habitat, reduce erosion, and improve water quality. On the other side of the coin, beaver sometimes damage valuable trees and crops or cause flooding that affects farmland, roads, and residential areas. Regulated trapping helps to strike a balance



Beaver Steve from Washington, DC, USA



Front:
Length – 2”
Width – 2”

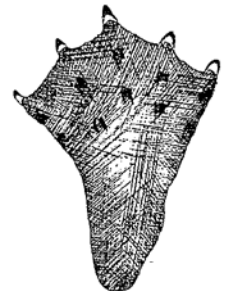

Hind:
Length – 5+”
Width - 5½”



Track pattern with marks of tail and fur dragging.



Bobcat

USFWS Photo



Front:
Length - 2"
Width - 1 1/8"



Hind:
Length - 1 7/8"
Width - 1 1/8"

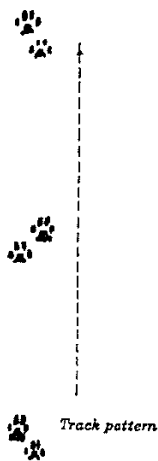

Track pattern

between the needs of people and nature by keeping the State's beaver population at a healthy but tolerable level. It also allows the use of an abundant, renewable resource.

Bobcat

Distribution: Common in the southern quarter of the State and occur in lower numbers along the Mississippi, Kaskaskia and Illinois rivers. Found sporadically in the remainder of the State.

Habitat: Forested or wooded areas, especially those with immature trees, thick underbrush, occasional clearings, cliffs, and timbered swamps.

Habits: Viewed by many as a "wilderness species," the bobcat's secretive habits allow it to live surprisingly close to people. They are most active at night and during the twilight hours of dusk and dawn. Daytime movements are rare except during the breeding season.

Territories of adult males average eight square miles and usually overlap those of two or more adult females. It's rare to find two adult females sharing the same area. Both sexes tolerate the presence of bobcats that are too young to breed.

Bobcats are curious animals, zig-zagging to investigate objects that catch their attention. They usually move at a walk or trot. Dirt roads, railways, and game trails are common travel routes between resting and hunting areas.

Foods: Common prey include rabbits, squirrels, birds, and rodents like mice, voles, and rats. Bobcats gorge themselves when food is plentiful and might not feed again for several days.

Reproduction: Mating peaks in February but can last from early January through June. Most litters arrive in late April or early May. Litter sizes vary from 1-6 but average 2-3 kittens.

Conservation: Maintaining and managing forest habitats are important conservation measures. This includes protecting some of the more unique areas in the state. More often than not, it also calls for thinning and harvesting trees to maintain the habitat diversity that bobcats prefer. State foresters and private consultants can help landowners to manage wooded areas for both economic and ecological values.

Coyote

Distribution: Common throughout the State. The highest numbers are found in west-central and southeastern Illinois.

Habitat: Coyotes occur in nearly all types of habitat, including urban and suburban areas. They are most common in areas with a mixture of farmland, woodland, and grassland.

Habits: During most of the year, coyotes travel over large areas, often 20-30 miles in diameter. This “territory” is not exclusive - several coyotes might share parts or all of it. They sometimes travel in groups – usually pairs, females and their pups, or several males pursuing the same mate.

Coyotes use a variety of barks, yips, and howls to communicate. Much like domestic dogs, coyotes also mark areas with urine, feces, or gland secretions.

Ridges, game trails, and farm lanes are preferred travel routes. They are most active from dusk until dawn; but they are sometimes seen at other times of day, especially during the mating season. The young are usually raised in dens. Dens, culverts, and brush piles are sometimes used for daytime resting or escape cover, especially in winter.

Foods: Common prey include rabbits, mice, and voles. Entrails and wounded or unrecovered deer are an important food source during and after the archery and gun deer seasons. They also eat insects, fruits, and berries when these items are abundant.

Reproduction: Most females have their first litter at two years of age. Breeding peaks in late February or early March. Pups are born in late April or May.

Both parents help to care for the young, especially after they are weaned. Many pups leave their parents in the fall and have been known to travel as far as 120 miles away.

Diseases: Distemper is one of the more common and serious diseases. Approximately 18% of the coyotes tested in Illinois had heartworms. Mange is caused by a parasitic mite and is a common ailment. In severe cases, coyotes lose most of their hair and are covered by scabs and open sores.

Conservation: The State’s coyote population increased dramatically during the 1970s. One theory links this increase to recovery of white-tailed deer populations in the east and Midwest portion of the United States. While coyotes kill few adult deer, they take newborn fawns and scavenge anything hunters leave behind while field-dressing their deer in the fall and winter.



Coyote

USFWS Photo



Front:
Length - 2 $\frac{3}{8}$ "
Width - 2 $\frac{1}{8}$ "



Hind:
Length - 2 $\frac{3}{8}$ "
Width - 2"



Track pattern



Gray Fox

USFWS Photo



Front:
Length - 1 1/8"
Width - 1 3/4"



Hind:
Length - 1 1/2"
Width - 1 1/4"



Track pattern

Surveys indicate that the statewide coyote population leveled off in the 1980s and has been stable since that time. A year-round hunting season allows landowners to remove problem animals without obtaining special permits. Trapping seasons are restricted to fall and winter.

Gray Fox

Distribution: A common inhabitant of wooded areas throughout the state. They are most abundant in west-central and southern Illinois.

Habitat: The gray fox lives in wooded or brushy areas. Good habitat can support as many as 3-5 foxes per square mile. Typical den sites include rock formations, hollow logs or trees, burrows, and brush piles.

Habits: The gray fox is most active from dusk to dawn. It can climb trees by using its front feet to grasp the trunk and hind feet to push upward. Gray foxes have been found in squirrel nests and abandoned hawk nests as much as 60 feet above the ground. This habit is useful for escaping enemies, sunbathing, and eating fruit.

Usually shy and secretive, gray foxes can fiercely fight when necessary. They can run up to 26 miles per hour for short distances.

Foods: Rabbits and rodents make up the bulk of their diet. Corn, grapes, berries, and fruits, like persimmons, can be important foods at certain times of the year.

Reproduction: Breeding peaks in February and early March. Gray foxes produce a single, annual litter of 1-10 pups, with an average of 3-5. Family groups break up in late summer or early fall.

Conservation: Maintaining and managing wooded areas are important conservation measures. While this includes protection of some unique areas, it also calls for thinning and harvesting trees to maintain a healthy, productive ecosystem. State foresters and private consultants can help landowners to manage their property for both economic and ecological values.

Biologists use several methods to track changes in the State's gray fox population. One of the simplest and most useful method relies on archery deer hunters who volunteer to keep a log of time they spend hunting and types of wildlife they observe. Biologists use the number of sightings per 1,000 hours to detect major changes in the abundance of gray foxes and other kinds of wildlife.

Mink

Distribution: Common statewide. Most abundant in the glacial lakes area of northeastern Illinois, counties bordering the lower Mississippi River, and the southern third of the state.

Habitat: Mink live along rivers, lakes, streams, ponds, and marshes. Shorelines with grass, brush, trees, or aquatic vegetation like cattails provide good cover and abundant prey. Abandoned muskrat burrows are their favorite places to rest and raise young, but they will also use cavities in brush or rock piles, logjams or the exposed roots of trees.

Habits: Mink are most active from dusk to dawn. Nearly all of their time is spent within 100 feet of the water's edge, but they will occasionally cut across open country from one body of water to another.

Male mink travel extensively, moving from one temporary den to the next in an area as large as five square miles. They may take as long as 2-3 weeks to complete their "circuit" and return to the starting point. Females live in a much smaller area, usually 20-25 acres in size.

Foods: Mink hunt in the water, on the shoreline, and in nearby upland areas. Frogs, fish, mice, rats, birds, crayfish, squirrels, rabbits, and muskrats are common prey.

Reproduction: A single annual litter of 2-7 young (an average of 4) is born around the first of May. Kits begin learning how to hunt at 6-8 weeks of age and can care for themselves by late summer.

Conservation: Mink are common enough to allow a limited trapping season, which begins in the fall and ends during winter, when pelts are marketable, and the young are on their own.

Maintaining and improving habitat are the most important conservation measures. The mink has benefitted from State and Federal programs that reimburse farmers for planting and maintaining grass and trees along streams and rivers. Some other practices that benefit this species include conservation tillage, managed grazing, wetland restoration, and regulations that protect water quality.



Mink

USFW Photo



Front:
Length - 1"
Width - 1 3/8"



Hind:
Length - 1 1/8"
Width - 1 1/2"



Track pattern



Muskrat

USFWS Photo



Front:
Length – 1"
Width – 1"



Hind:
Length – 2"
Width – 2"

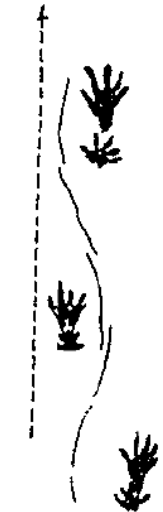

Track pattern

Muskrat

Distribution: Common throughout Illinois. Some of the highest numbers occur in the northeastern and northwestern parts of the state.

Habitat: Muskrats live in rivers, streams, lakes, ponds, drainage ditches, marshes, and swamps.

Habits: Muskrats are most active at night. However, it is not unusual to see one in the early morning or late afternoon. Movements of more than a few hundred feet from a lodge or den are rare, except during early spring and late summer when some strike out to find a new home.

Muskrats that live in areas with shallow, stable water levels (like marshes) often build dome-shaped houses by cutting and piling up cattails, bulrushes, or other aquatic vegetation. Some are 8' or more in diameter at the base and have walls 1-2' thick. Tunnels angle upward from underwater entrances (usually two or more) to an inside chamber that is hollowed out above the water line.

Muskrats that live in streams, rivers, lakes, and ponds usually burrow directly into the banks rather than building houses. Trails hollowed out in front of the underwater entrances are sometimes visible, especially along well-used routes. Burrows dug into the dams of manmade ponds can wash out during high water, causing the ponds to drain.

Foods: In marshes, muskrats eat the roots and stems of plants like cattail, bulrush, arrowhead, and water lily. Clover, grasses, and corn are common foods in agriculture areas. They occasionally eat mussels, snails, crayfish, frogs, and fish when these items are easy to catch.

Reproduction: Most females have two litters per year. A typical litter has 4-7 young.

Conservation: Maintaining and improving habitat are the most important conservation measures. Muskrats have benefitted from State and Federal programs that reimburse farmers for planting and maintaining grass and trees along streams and rivers. Some other practices that benefit this species include conservation tillage, managed grazing, wetland restoration, and regulations that protect water quality.

People who own ponds and lakefront homes sometimes consider muskrats a nuisance because of damage their burrows can cause to banks or dams. Trapping during the legal season can help to alleviate these problems while making use of a natural, renewable resource.

Opossum

Distribution: Common throughout the State. They are most abundant in southern Illinois, especially along the Wabash, Mississippi and Ohio rivers. High numbers also occur in some urban and suburban areas.

Habitat: Wooded areas near streams provide good habitat. Dens are located in hollow logs or trees, dry culverts, burrows dug by other species, sheds or old buildings, and cavities in rock, brush piles, or trash heaps.

Habits: Opossums are slow, secretive, and solitary. They venture from their dens at night to look for food, traveling distances of ½ -2 miles depending on food availability and time of year. The opossum does not hibernate but may stay in its den for several days during periods of extreme cold or deep snowfall.

Opossums often climb trees or run for cover when chased. They are well known for “playing possum” when unable to escape. This reaction is caused by nervous shock, but the opossum recovers quickly and continues on its way.

Foods: Opossums eat both plant and animal matter. Insects, carrion (dead animals), birds and their eggs, frogs, snails, earthworms, fruits, and berries are typical fare. Corn is an important part of the diet in agricultural areas, as is trash, bird food, and pet food in urban and suburban areas.

Reproduction: The breeding season begins in early February. Most females have one litter per year, but some have two. Each litter contains an average of 9 young.

Opossums are the only marsupial (pouched mammal) in North America. The young, which are not fully developed when born, make their way to the protection of the pouch or perish. Upon arriving, they grasp onto a nipple and stay attached for about two months. They leave the pouch at 80 days of age and begin living on their own at about 100 days.

Conservation: Few people try to improve habitat specifically for opossums because they are abundant and adapt easily to a wide range of habitat conditions. Measures that maintain woodlots, fencerows, and hardwood forests are beneficial, as are forestry practices that leave some old trees uncut during logging operations.



Opossum

USFWS Photo

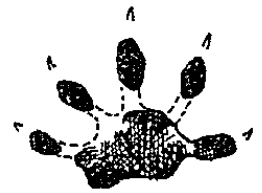

Front:
Length - 1 $\frac{7}{8}$ "
Width - 2"



Hind:
Length - 2 $\frac{1}{2}$ "
Width - 2 $\frac{1}{4}$ "



Track pattern



Raccoon USFWS Photo



Front:
Length – 3”
Width – 3”



Hind:
Length - 3¾”
Width - 3¾”



Track pattern

Raccoon

Distribution: Common throughout the State.

Habitat: Raccoons occur in nearly all types of habitat. They are most abundant in suburban areas and those with fairly equal parts of cropland and woodland.

Habits: Raccoons are mostly nocturnal. During most of the year, adult males occupy an area up to one mile in diameter. Adult females and their young live in smaller area, usually ¼ of a mile in diameter. An area used by one raccoon can overlap that of another. Densities of 9-45 raccoons per square mile are common in Illinois.

Dens are found in tree cavities, burrows excavated and abandoned by other animals, haystacks, storm sewers, old building, and even attics. Raccoons do not hibernate, but they sometimes stay in their dens for several days during periods of extreme cold or deep snowfall.

Areas frequented by raccoons at any given time tend to be those with the most abundant and reliable food sources – this might be a pond, stream or river, corn field, silo or a grove of oak, pecan or persimmon trees.

Foods: Corn is an important food in agricultural areas. Bird food, pet food, and table scraps are mainstays in suburban habitats. Some of their other favorites include persimmons, wild grapes, wild plums, blackberries, acorns, pokeberries, insects, fish, frogs, and small mammals.

Reproduction: Breeding peaks in February but can occur from January through March. One litter of 3-4 pups is typical. Most are born in April or early May, but a few arrive as late as August.

Diseases: Distemper is common in raccoons, with 20-30% exposed to this disease at some point in their lives. Distemper does not affect humans but can be passed on to domestic dogs and other kinds of wildlife.

Leptospirosis affects nearly 50% of raccoons at some point in their lives. Humans can get this disease from coming in contact with infected urine or contaminated water. Flu-like symptoms are most common, but jaundice, kidney failure, and death can occur in severe cases.

Raccoon roundworms are common parasites, affecting about 70% of juveniles and 30% of adults. Roundworm infections cause few problems

for raccoons but can lead to serious ones in humans. In rare cases, partial blindness and death can result.

Conservation: Raccoons are popular animals because they are common and often entertaining. However, they can cause problems, especially where they occur in large numbers or close to people. Concerns include the spread of diseases and parasites, damage to crops and homes, and predation on other kinds of wildlife. Hunting and trapping can help to reduce these problems, especially in rural areas.

Red fox

Distribution: Found throughout Illinois, but most common in the northern two-thirds of the State.

Habitat: Red foxes prefer grasslands and other open areas. They use crop fields but are more likely to spend time near marshes, fencerows, pastures, drainage ditches, fallow crop fields, and woodlots while searching for prey. Reports of red foxes living in urban and suburban areas have increased during recent years.

Habits: Burrows dug by woodchucks, badgers, or other animals are common den sites, as are abandoned or little-used outbuildings. Adults usually stay within a mile of their dens while raising pups. At other times of the year, they live in an area 5-10 miles in diameter. Juveniles usually leave their parents in the fall and have been known to travel as far as 100 miles before setting up housekeeping for themselves.

Red foxes are most active at night. They sometimes travel the same paths over and over, creating worn trails. They stop frequently to urinate on prominent objects. Feces and gland secretions are also used to mark their homesteads.

Foods: Rodents and rabbits make up about 60% of their diet. Other foods include birds, carrion (dead animals), and insects.

Reproduction: Mating takes place from December to March but peaks in January. Most litters are born in late March or early April. Litter sizes vary from 1-10, with an average of 4-5 pups.

Conservation: Red foxes are abundant enough to allow limited hunting and trapping seasons without endangering the health of the overall population. Seasons occur in the fall and winter, when pelts are marketable, and the pups are fully grown.

Red foxes benefit from government programs that pay farmers to plant grasses and other permanent cover in crop fields that have problems with soil erosion or are located along waterways. Foxes also benefit



Red fox

USFWS Photo



Front:
Length - $2\frac{3}{8}$ "
Width - 2"



Hind:
Length - $2\frac{1}{8}$ "
Width - 2"



Track pattern



River otter

USFWS Photo



Front:
Length - 3¾"
Width - 3¾"

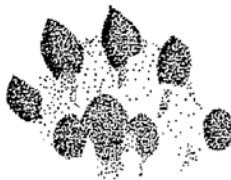

Hind:
Length - 3¾"
Width - 3¾"



Track pattern

from managed grazing, planting native trees and shrubs for windbreaks, restoring wetlands, and planting patches of native grasses.

River otter

Distribution: Found throughout Illinois. Most common in the southern, west-central and northwestern parts of the State.

Habitat: Rivers, streams and lakes are key habitats. Those with wooded shorelines and wetlands nearby are best.

Habits: River otters are most active at night. Adult males live along large stretches of river, often up to 40-50 miles in length. Females are not nearly as mobile. Their home range is only 3-10 miles in length. Areas with a concentration of rivers, lakes, ponds, and marshes tend to support more otters than those that are less diverse.

River otters travel a lot but spend most of their time at “activity centers” where food and cover are concentrated. Examples include oxbows, pools below dams or spillways, and springs or riffles that stay free of ice all winter.

River otters can stay submerged for 3-4 minutes and swim up to a quarter mile underwater. They have a bounding or loping gait on land. When it snows, they often bound for a few steps then slide on their belly, leaving an unmistakable dot-dash pattern.

Foods: Fish are the river otter’s main prey. Species like carp, sunfish, and shad are preferred because they are abundant and easy to catch. Other common foods include frogs and crayfish.

Reproduction: Most females have their first litter at two years of age. An average of 2-4 pups arrive between January and May.

Conservation: Conserving wetlands and wooded areas along streams and rivers are top priorities. Water quality has improved tremendously since the 1970s thanks to laws that cut down on pollution. This has benefitted both the river otters and its prey.

River otters were nearly extirpated from Illinois by the late 1800s. A study conducted in the 1980s estimated that fewer than 100 existed in the State, located mostly in extreme northwestern and southern Illinois.

A total of 346 river otters captured in Louisiana with small leghold traps were released in Illinois from 1994-1997. This, along with growth of populations that already existed, have allowed the river otter to reclaim much of its former range in Illinois. Numbers are still low in some areas but are growing quickly.

Striped skunk

Distribution: Common throughout the State. Rural areas with rolling hills or bluffs and a mixture of farmland, timber and pastureland tend to support the highest numbers. Also abundant in some suburban areas, especially those near railroads or rights-of-way for high-tension power lines because these features often provide travel-ways and denning sites.

Habitat: Striped skunks use a wide variety of habitats but prefer forest borders, brushy areas, and open, grassy fields broken by wooded ravines and rock formations. A permanent source of water adds to the attractiveness of a site.

Habits: Striped skunks can dig their own dens, but prefer to use those excavated by woodchucks, badgers, or other animals. Den sites also include stumps, caves, rock piles, old buildings, junk piles, sheds, wood piles, and dry drainage tiles or storm sewers.

Skunks are most active at night. They live in an area 1-1 ½ miles in diameter but use only a small part of this on any given night.

Skunks are slow-moving and docile. Their senses of sight, smell and hearing are poor compared to most predators. Their strong-smelling musk is their best defense. Before discharging it, they usually face their intruder, arch their backs, raise their tails, and stamp the ground with their front feet.

Foods: Insects are their preferred food and make up most of their diet in spring and summer. Other common foods include mice, young rabbits, birds and their eggs, corn, fruit, and berries.

Reproduction: Breeding begins in February and lasts through March. A single litter of 4-10 young is born from early May to early June.

Diseases: Skunks are susceptible to diseases like rabies, canine distemper, and leptospirosis. Until recently, their numbers went through boom and bust cycles linked to rabies outbreaks. The last epidemic occurred in the early 1980s. Their numbers have remained low but stable since that time.

Conservation: Little habitat management occurs specifically for striped skunks. However, they benefit from practices aimed at improving conditions for other wildlife like government programs that pay farmers to plant grasses and other permanent cover in crop fields that have problems with soil erosion or are located along waterways.



Striped skunk Missouri Dept. of Cons.



Front:
Length - $\frac{7}{8}$ "
Width - $1\frac{1}{8}$ "



Hind:
Length - $1\frac{1}{2}$ "
Width - $1\frac{1}{2}$ "



Track pattern



Weasel

USFWS Photo



Front:
Length - 1½"
Width - ½"



Hind:
Length - 1½"
Width - ¾"



Track pattern

Weasel

Distribution: Two species occur in Illinois – the long-tailed and least weasels. Long-tailed weasels occur throughout the State. Least weasels occur only in the northern half of Illinois. While widespread, both species tend to be uncommon.

Habitat: Long-tailed weasels are found in a wide variety of habitats but prefer forests, woodlands, thickets, and brushy fencerows. Least weasels tend to be found in areas like meadows, grasslands, and river bottoms. Both species do best where they find permanent water and high populations of rodents.

Habits: Weasels are sometimes seen during the daytime but tend to be most active at night. The least weasel might live in an area as small as 2-2 ½ acres where food is abundant, or as large as 37-65 acres where food is scarce. The same holds true for long-tailed weasels, with home ranges varying from 25-400 acres in size.

Both species follow regular hunting routes, covering only a small portion of their home range on any given night. Males travel farther than females.

Foods: Long-tailed weasels eat mice, rats, voles, chipmunks, shrews, moles, and rabbits. Less common foods include birds, bird eggs, snakes, frogs, and insects. Least weasels specialize in taking small prey like mice and voles. Their tiny size allows them to hunt and kill rodents in their own tunnels.

Reproduction: Least weasels can breed year-round. They usually produce a single litter when rodent populations are low and as many as 2-3 when the opposite is true. An average litter has 4-5 young. Long-tailed weasels have only one litter of 4-5 young per year, usually in April or May.

Conservation: Illinois allows a limited trapping season for weasels, Few are taken because populations are scattered, and only few trappers make an effort to catch them unless they are causing damage like killing poultry.

Planting strips of grass along creeks, streams, and rivers provides habitat for weasels and their prey while reducing soil erosion and runoff from heavy rains. Planting native trees and shrubs along fencerows or in windbreaks helps to reduce soil erosion and provide habitat for wildlife. In some areas, building brush piles is beneficial.

Minnesota Trappers Association
www.mntrappers.org
Body Gripper Removal Instructions

Although an uncommon occurrence, domestic animals have at times been accidentally caught in body gripping traps. Sadly, in most cases the reason that animals were ultimately lost was due primarily to a lack of familiarity with these devices by the person attempting to free the animal. The handout, which is included on the following pages, is an attempt to educate outdoor enthusiasts in the proper method of releasing an accidentally caught animal.

The zip ties used to remove a Body Grip Trap must be made of nylon, preferably nylon 6/6 adhering to ASTM-D4066 PA 181 and have a rated strength of 175 pounds or more.

ZIP TIE METHOD OF REMOVING A BODY GRIP TRAP

Minnesota Trappers Association

www.mntrappers.org



An educational tool provided to pet owners.

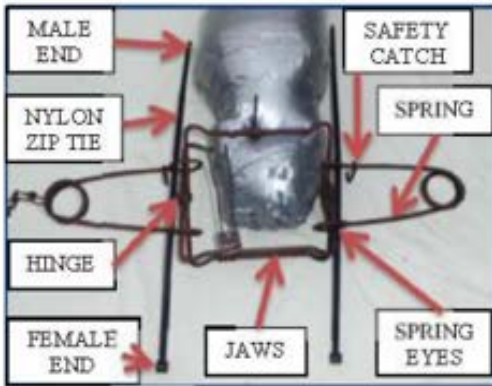

Figure (1)

Although an uncommon occurrence, domestic animals have at times been accidentally caught in body gripping traps. Sadly in most cases, the reason that animals were ultimately lost was due primarily to a lack of familiarity with these devices by the person attempting to free the animal. This handout is an attempt to educate the outdoor enthusiast in the proper method of releasing an accidentally caught animal.

Do not attempt to pry the jaws apart as the springs will prevent the trap from being forcefully opened in this manner in most cases.



FIGURE 2

REMAIN CALM – Speak soothingly to the animal. This will help reassure the animal and make your job easier.

If available seek assistance to help restrain the animal to make the following steps quicker and easier.

THREAD 1 ZIP TIE THROUGH THE SPRING EYES OF A SPRING AS SHOWN. VERIFY THAT YOU ARE THROUGH THE SPRING EYES ON THE OUTSIDE OF THE JAW AND HINGE.

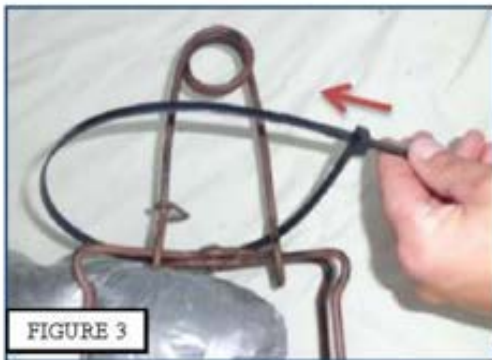

FIGURE 3

THREAD THE MALE END OF THE ZIP TIE THROUGH THE FEMALE END OF THE ZIP TIE AS SHOWN. SNUG UP TO THE SPRING EYES WITH YOUR FINGERS AS FAR AS POSSIBLE.

(NOTE: You will hear the teeth of the zip tie clicking as it tightens and it will hold the spring compressed. If it is not doing this make sure you threaded the zip tie correctly. See figure #3.)

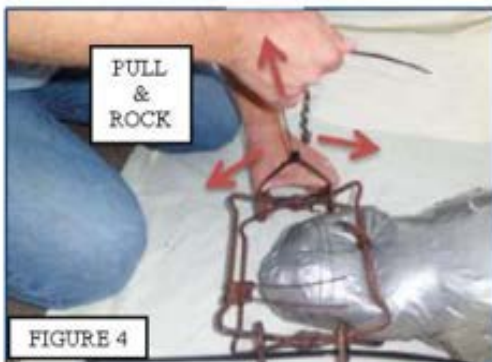
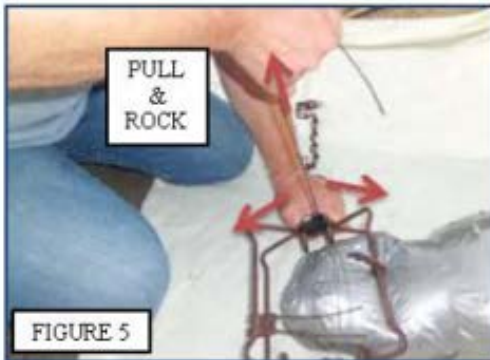

FIGURE 4

COMPRESS SPRING (HAND METHOD)

WITH ONE HAND GRIP THE SPRING ENDS AS FAR IN TOWARDS THE JAW AS POSSIBLE. WITH THE OTHER HAND SOLIDLY GRIP THE MALE END OF THE ZIP TIE. SQUEEZE THE SPRING AND PULL UP HARD ON THE ZIP TIE AT THE SAME TIME. IT MAY HELP TO WIGGLE THE ZIP TIE BACK AND FORTH WHILE PULLING TO HELP THE ZIP TIE CLOSE EASIER.



KEEP PULLING AND SQUEEZING UNTIL THE SPRING EYES ARE ABOUT 1.5" APART. (SEE PICTURE)

REPEAT THE PREVIOUS STEPS FOR THE SECOND SPRING.

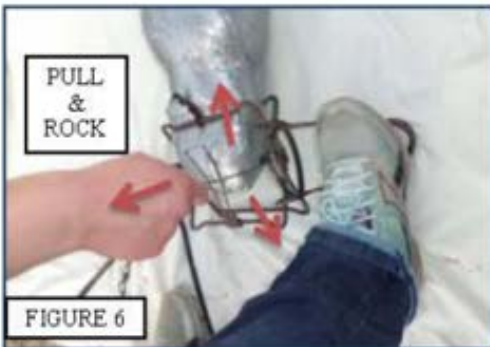

COMPRESS SPRING (FOOT METHOD)

(This method may be easier if you have smaller or weaker hands.)

PLACE YOUR FOOT ON THE SPRING AS SHOWN. WITH ONE OR TWO HANDS GRIP THE MALE END OF THE ZIP TIE AND PULL HARD WHILE WIGGLING THE ZIP TIE BACK AND FORTH. THIS WILL COMPRESS THE SPRING.

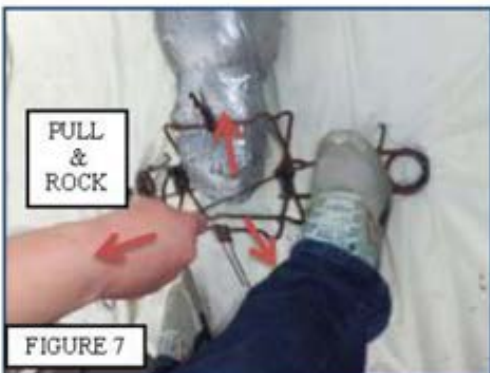

KEEP PULLING UNTIL THE SPRING EYES ARE ABOUT 1.5" APART. (SEE PICTURE)

REPEAT THE PREVIOUS STEPS FOR THE SECOND SPRING.



ONCE BOTH SPRINGS HAVE BEEN COMPRESSED AS SHOWN ABOVE, THE PRESSURE WILL BE OFF OF THE JAWS OF THE TRAP. YOU CAN NOW REMOVE THE TRAP. IT IS NECESSARY THAT THE COMPRESSED SPRINGS BE CENTERED OVER THE HINGE OF THE JAWS. THIS ALLOWS THE JAWS TO ROTATE AWAY FROM THE ANIMAL. WIGGLE THE TRAP BACK AND FORTH AND PULL AWAY UNTIL FREE.

**Zip ties used to remove a Body Grip Trap must be made of nylon, preferably nylon 6/6 adhering to ASTM D4066 PA181, and have a rated strength of 175lbs or more.*

© 2015 Minnesota Trappers Association. The Minnesota Trappers Association grants permission to duplicate and distribute unaltered copies of these instructions for educational purposes. Any questions regarding these instructions should be directed to www.mnta.org

TRAP SIZE GUIDE FOR ILLINOIS FURBEARERS

(All measurements given in inches)

Species	Foothold		Trap Types	
	Jaw spread	Size	Body-gripping Jaw spread	Box trap Length, Width & Height
Badger	4½" - 5½"	1½, 1¾, 2, 3, 1½ & 3 padded	7" **	***
Beaver ***	5½" - 7½"	2, 3, 4	7" - 10"	***
Bobcat	4½" - 6½"	1¾, 2, 3		42" x 15" x 20"
Coyote	5½" - 6"	1¾, 2, 3, 3 padded	***	***
Fox, Gray	4½" - 5½"	1½, 1¾, 2, 1½ padded	***	***
Fox, Red	4½" - 5½"	1½, 1¾, 2, 1½ padded	***	***
Mink ****	4" - 5"	1, 1½, 11, 2	4½" - 6"	19" x 6" x 6"
Muskrat ****	4" - 5"	1, 1½, 11, 1 & 1½ Stoploss™	4½" - 6"	19" x 6" x 6"
Opossum	4" - 5"	1, 1½, 1 & 1½ padded EGG®, Grizz®	6" - 7" **	20" x 7" x 7"
Raccoon	4" - 5½"	1, 1½, 11, 2, EGG®, Grizz®	6" - 7" **	32" x 10" x 10"
River otter ***	3¾" - 5"	1½, 1¾, 11, 2, 3, 4, 5	7" - 10"	***
Striped skunk	4" - 5"	1, 1½, 11	6" - 7" **	20" x 7" x 7"
Weasel	3½" - 4"	0, 1	4½" **	16" x 5" x 5"

- * Dimensions given are minimum sizes for single door traps; double door traps should be longer than the lengths listed.
- ** USE ONLY WITH EXTREME CAUTION when setting on land to avoid catching and killing non-target animals.
- *** Trap types without dimensions for a particular species are either ineffective or not normally recommended for this species.
- **** Always use submersion (drowning) sets for this species when using foothold traps.

SELECTED REFERENCES

Wildlife Management & Ecology

Conservation and the Use of Wildlife Resources, edited by M. Bolton, Chapman & Hall, Florence, KY, 1997. ISBN:0-41 271 -350-0

Mammals of Illinois, by D. F. Hoffmeister. University of Illinois Press, Urbana, 1989. ISBN:0-252-01515-0

Wild Mammals of North America: Biology, Management and Economics, edited by J.A. Chapman and G.A. Feldhamer. The Johns Hopkins University Press, Baltimore, MD, 1982. ISBN:0-8018-2353-6

Wild Furbearer Management and Conservation in North America, edited by M. Novak, J.A. Baker, M.E. Obbard and B. Malloch. Ontario Trappers Assoc., Toronto, 1987. ISBN:0-7743-9365-3

Practical Wildlife Management by G. V. Burger. Winchester Press, New York, NY. 1976. ISBN; 0-87691-099

Wildlife-Habitat Relationships: Concepts and Applications, by M.L. Morrison, B.G. Marcot and W.Mannan, University of Wisconsin Press, Madison, 1998.

Urban Wildlife Habitats: A Landscape Perspective, by L.W. Adams, University of Minnesota Press, Minneapolis, 1994. ISBN80-8166-2212-4

Techniques for Wildlife Management of Wetlands, edited by N.F. Payne, McGraw-Hill, Inc., New York, 1992. ISBN:0-07-048956-4

Techniques for Wildlife Management of Uplands, edited by N.F. Payne and F.C. Bryant, McGraw-Hill, Inc., New York, 1994. ISBN:0-07-048966-1

Prairie Establishment and Landscaping. by W.E. McClain, Illinois Department of Natural Resources, Springfield, 1997. (Natural Heritage Technical Bulletin #9)

A Sand County Almanac, by A Leopold, Oxford University Press, New York, 1991. ISBN:0.-345- 25336-1

Species Accounts

Beavers: Water, Wildlife and History. by E.L. Hilfiker, Windswept Press, Interlaken, NY, 1982. ISBN:1-55787-068-3

The Biology of the Striped Skunk, by B.J. Verts, University of Illinois Press, Urbana, 1967.

Eastern Coyote: The Story of Its Success, by G. Parker, Nimbus Publishing, Halifax, Nova Scotia, 1995. ISBN:1-55109-111-9

Muskrats and Marsh Management by P.L. Errington, Stackpole Co., Harrisburg, PA and The Wildlife Management Institute, Washington, D.C., 1961.

Illinois River Otter Recovery Plan, edited by R.D. Bluett, Illinois Department of Natural Resources, Springfield, IL, 1995. (Wildlife Resources Technical Bulletin #7)

Ecology and Management of the Eastern Coyote, by A.H. Boer, Wildlife Research Unit, University of New Brunswick, Fredericton, NB, 1992. ISBN:0- 920114-17-2

Red Fox - The Catlike Canine, by J.D. Henry, Smithsonian Institution Press, Washington, D.C. 1986. ISBN: 1-56098-635-2

Wildlife Diseases

Infectious Diseases of Wild Mammals, edited by J.W. Davis, L.H. Karstad and D.O. Trainer, The Iowa State University Press, Ames, 1971. ISBN:0-8138-0445-0

Parasitic Diseases of Wild Mammals, edited by J.W. Davis and R.C. Anderson, The Iowa State University Press, Ames, 1971. ISBN:0-8138-1240-

Web Resources

Addresses for the following companies are provided for the convenience of students seeking trapping supplies or related services and does not imply endorsement nor preference by IDNR:

Illinois Department of Natural Resources
<http://www.dnr.illinois.gov>

U.S. Fish & Wildlife Service
www.fws.gov

Sport Fish & Wildlife Restoration Program
<http://wsfrprograms.fws.gov>

Ecology and Conservation of Illinois' Fur Resources
cms.inhs.illinois.edu

National Trappers Association
www.nationaltrappers.com

Illinois Trappers Association
<http://www.illinoistrappersassociation.com>

Furtakers of America
<http://www.furtakersofamerica.com>

Fur Information Council of America
www.fur.org

Fur Institute of Canada
www.fur.ca

International Fur Trade Federation
www.wearefur.com

Wildlife Legislative Fund of America
<http://www.sportsmenalliance.org>

The Wildlife Society
www.wildlife.org

International Association of Fish & Wildlife Agencies www.fishwildlife.org
(includes information and updates on Best Management Practices)

Outdoors Minnesota
www.outdoornews.com/minnesota

Minnesota Trappers Association
www.mntrappers.org

Intro to Missouri's Furbearers
Hunting4predators.blogspot.com/2010/01/introduction-to-missouris-furbearers.html

North American Trap Collectors
www.usedtraps.com/natca/

Searchable field guides for 4800 plants and animals
www.enature.com

Groenewold Fur & Wool Co.
www.gfwco.com

North American Fur Auctions
www.nafa.ca

Fur Harvesters Auction, Inc.
www.furharvesters.com

Trapper and Predator Caller Magazine
www.trapperpredatorcaller.com

Dobbins' Products
<http://trapperman.com/supplies>

Murray's Lures & Trapping Supplies
www.murrayslures.com

Minnesota Trapline Products
www.minntrapprod.com

Chagnon 's Trapping Supply
www.pcsoutdoors.com

